

# Brakes

ISSUES 40-45, 50

As a subscriber to a number of publications, your editor happened upon an article on braking systems in [Grassroots Motorsports](#). As I searched for an answer to better brake performance, I realized that I was concentrating my efforts (read: money) somewhat in the wrong direction. After reading author James Walker's article, I knew that I had to get this information to the TDR audience. I made some phone calls to inquire, and now I am pleased to present James' article complete with some custom tweaks for us, the Turbo Diesel audience.

## BRAKING SYSTEMS IN PLAIN ENGLISH

By James Walker, Jr. of SCR Motorsports

Readers of this publication often see advertisements describing brake upgrades available to diesel enthusiasts. However, before any of us go running off to the aftermarket for our own NASCAR six-piston calipers, F1 carbon-fiber rotors, and 50 feet of stainless steel braided brake lines, it would be wise to take a deeper look into braking systems. You just might find that once you gain a fundamental understanding of what each of these components **really** does (and more importantly, what each does **not** do), you will be better prepared to make the right decisions when modifying (or choosing not to modify) your own rides.

## WHAT DO BRAKING SYSTEMS REALLY DO?

So, here comes the first surprise. Your brakes do not stop your truck. The traction available between the road and the tire's four contact patches—where the rubber meets the road, so to speak—is the limiting factor when everything comes to a halt. For all intent and purposes, this could complete our article, but because a two paragraph story doesn't read too well, I suppose we should continue to discuss the actual purpose of the braking system.

Of course, the next question is: "What do the brakes do?" In plain English, your brakes convert the energy of motion into heat. An engineer would say the brakes are responsible for turning the kinetic energy of your speeding truck into thermal energy. The engineer would also be able to tell us (kind of funny, but I am an engineer myself) that for every percent increase in vehicle weight, there is an equal percent increase in the amount of energy, and consequently, heat generated. For example, load up your 5000 pound truck to 8000 pounds (an increase of 60%) and your brakes will run 60% hotter, everything else being equal.

Even more interesting is the relationship between speed and heat. Unlike the one-to-one relationship with vehicle weight, the heat goes up with the increase in speed squared. In other words, if you make a stop in your truck from 45mph and another from 65mph (an increase of 44%), the amount of heat would increase by 209%! Little changes in speed make a big difference in heat, and as we will find out later, heat is usually the enemy.

Now let's look at each of the pieces of the braking system puzzle to understand just exactly how they convert the energy of motion into heat, and how this process results in tire traction stopping the truck.

Author's disclaimer: while the concepts, analysis, and functional descriptions of the brake system components described herein are 100% applicable to the TDR reader, the actual sizes and physical relationships used in this example are not from an actual Dodge product. Many of the values are from my race car, but the rest were chosen to make the math easy.

## THE MIGHTY BRAKE PEDAL

I'm hoping that you are all familiar with the brake pedal. But, while most of us probably think of the brake pedal only as the flat part that makes contact with the foot, remember that an equally important part of the brake pedal assembly, the output rod, continues out of sight. Together, these parts constitute the brake pedal assembly.

The sole function of the brake pedal assembly is to harness and multiply the force exerted by the driver's foot. It does this thanks to a concept known as leverage. We all learned the concept of leverage on a teeter-totter—the farther you sit from the middle (the pivot), the more weight you can lift on the other end. In the case of the brake pedal assembly, the pivot is at the top of the brake pedal arm, the pad (where we step) is on the opposite end, and the output rod is somewhere in between. In the example illustration (Figure 1), a driver input force of 90 pounds is multiplied by the 4:1 ratio into 360 pounds {90 lb. x 4} of output force.

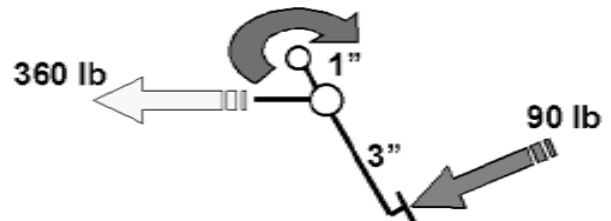

Figure 1 – The brake pedal as a simple lever

Does the output rod directly stop the truck? No. So would you want to make any changes to the brake pedal, and if you did, how would this impact the brake system performance? There are several answers, each with their own set of pros and cons:

- Increasing the ratio (8:1, for example) would further amplify driver input force, but would make the pedal travel through a longer distance to achieve the same output. In the given example, the 90 pound input would generate 720 pounds output, but with twice the pedal travel.
- Decreasing the ratio (3:1, for example) would reduce the overall size and weight of the brake pedal assembly, but would decrease the amount of amplification—the 360 pounds in the example would fall to just 270 pounds. To generate the same 360 pound output, the driver would need to press the pedal with 120 pounds of effort!

So, will changing the brake pedal make the truck stop any faster? Not by itself. But while one can tune the pedal output force and pedal travel characteristics by making changes to the pedal ratio, these parts (because of their complexity) are rarely found in the aftermarket.

## THE MASTER CYLINDER

The next step in the brake system is to convert the amplified force from the brake pedal into hydraulic fluid pressure. The master cylinder, consisting of a piston in a sealed bore with the brake pedal output rod on the one side and brake fluid on the other, performs this task. In addition, on most diesel-powered vehicles there is an auxiliary power supply unit commonly known as HydroBoost lumped into the assembly.

HydroBoost uses power steering fluid under pressure to increase the force coming from the brake pedal output rod before it pushes against the master cylinder piston. As the pedal assembly output rod pushes on the piston, the piston moves within the cylinder and pushes against the fluid, creating hydraulic pressure. It's really that simple; however, in order to determine how much pressure is generated at the master cylinder, we will need to dig into a few fluid calculations. Don't flip to the classified ads just yet!

The pressure generated at the master cylinder is equal to the amount of force from the brake pedal output rod (plus the HydroBoost contribution, say, an additional 325 pounds, for a total of 685 pounds) divided by the area of the master cylinder piston. If we assume a master cylinder diameter of 1.25 inches (with a resulting area of about 1.23 square inches), the calculated pressure will be 558 pounds per square inch (PSI) from the 685 lbs. of output force from above ( $685 \text{ lb.} \div 1.23 \text{ in}^2$ ).

Whew—no more math for a minute, just stare at Figure 2 for a while.

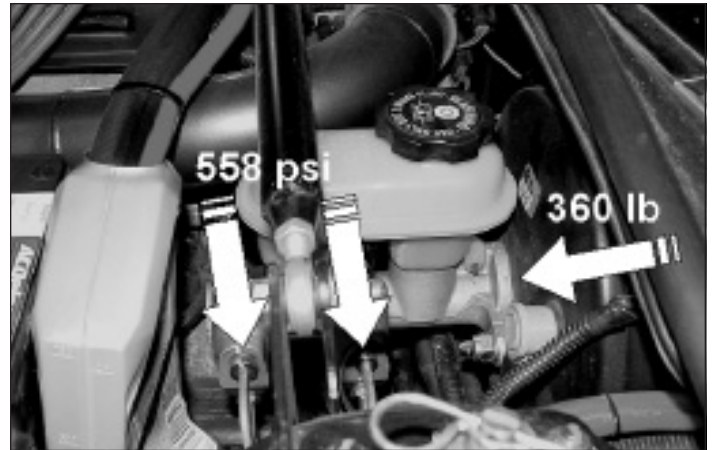

Figure 2 – The master cylinder generating pressure

So, does this pressurized hydraulic fluid stop the truck? Again, the answer is no, but like the brake pedal making changes to the master cylinder can impact other characteristics of the brake system:

- Increasing the master cylinder piston diameter will decrease the amount of pressure generated in the fluid for a given input force. Seems backwards, but that's the way it works out. In the example above, if a 1.375" master cylinder were to be substituted, the output pressure would fall to approximately 460 PSI—a pressure reduction of nearly 20% for a +0.125" change in diameter. Small changes here make a big difference.
- Decreasing the master cylinder piston diameter works the same principle in reverse. Swapping in a 1.125" master cylinder will increase pressure to just about 700 PSI—this time a 25% increase for a -0.125" change in diameter.

Given the relationship between master cylinder piston diameter and hydraulic force, it may seem desirable to use the smallest master cylinder possible. However, the braking system has to have enough additional hydraulic fluid on hand to fill all the extra volume caused by the flexing of components during the compliance phase (this is one reason that the brake fluid reservoir is so large as well). Unfortunately, this is accomplished by increasing the diameter of the master cylinder, which, we just learned, reduces the pressure generated! Therefore, one has to make sure that the master cylinder has a large enough diameter to meet the fluid volume requirements of the system, but small enough to generate the pressure required. (There's never an easy answer, is there?)

## THE BRAKE TUBES AND HOSES

On the surface, the brake tubes and hoses have one of the easiest jobs in the braking system—transporting the pressurized brake fluid away from the master cylinder to the four corners of the car. It would be ideal to use the most rigid material possible to minimize the compliance in the system. However, since the braking components at the wheels (calipers, pads, and rotors) are usually free to move around with the wheels and tires, a flexible portion is required—and flex equals compliance.

Traditionally, auto manufacturers have used rigid steel tubing and a short length of rubber coated nylon tubing to make the connection to the moving stuff, but even this short section of flexible tubing can significantly affect compliance. For this reason, it is sometimes preferred to replace the rubber hose with a nylon tube covered by stainless steel braiding (see Figure 3). Most people notice the reduction in brake pedal travel due to the reduced compliance immediately, but it usually depends on how old and flexible the old rubber coated hoses were at the time of replacement.

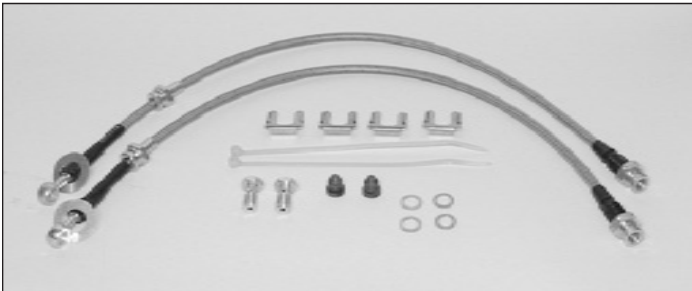

Figure 3 – Stainless steel brake hoses

Although those cool-looking stainless steel brake lines will not make your truck stop any faster on their own, the decrease in compliance and improvement in pedal feel can make a driver much more confident. They will probably provide some increased level of resistance to damage from flying debris as well. Did I mention they look cool?

### THE CALIPER

The caliper is one of the most familiar components, yet sometimes the most misunderstood. Like the master cylinder, the caliper is just a piston within a bore with pressurized fluid on one side. While the master cylinder used mechanical force on the input side to create hydraulic force on the output side, the caliper does the opposite by using hydraulic force on the input side to create mechanical force on the output side. The top view shown in Figure 4 illustrates how the pressurized brake fluid working against the back side of the piston is converted into a squeezing or clamping force.

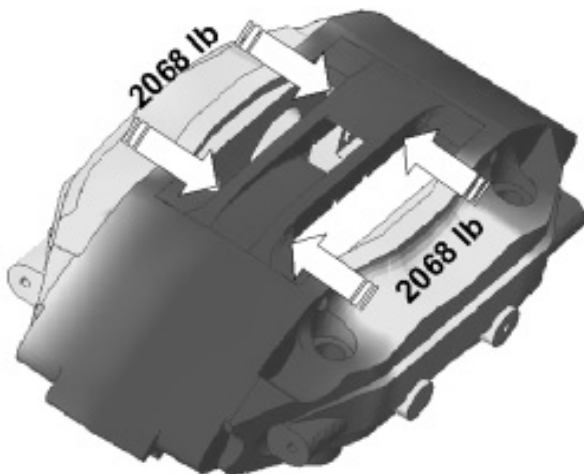

Figure 4 – Caliper clamping force

In order to calculate the amount of clamping force generated in the caliper, the incoming pressure is multiplied by the area of the caliper piston. In our example, the 558 PSI that had been generated at the master cylinder has traveled through the brake lines and hoses and is pushing against two 1.5” pistons per caliper. Therefore, the effective area of the caliper will be equal to two times the area of a single 1.5” piston. Working the numbers reveals that 558 PSI will generate 2,068 pounds of clamp load  $\{558 \text{ PSI} \times 1.84 \text{ in}^2 \times 2\}$ .

As you have probably already guessed, increasing the caliper piston diameter increases the clamp load for a given input pressure—but again, this does not stop the truck. Putting on bigger calipers might seem like a good idea at first, but the tradeoffs might make you think twice:

- Increasing the piston diameter will increase the compliance in the system (bad news for pedal feel!)
- Increasing the piston diameter will increase the size and weight of the caliper (bad news for unsprung weight!)
- Increasing the piston diameter will increase the fluid volume requirement of the system (bad news for master cylinder sizing!)

So, when thinking about that big-piston caliper conversion, keep in mind that the size and number of caliper pistons on your truck were originally matched to the brake pedal and master cylinder to generate an appropriate clamp load for a given brake pedal input force. Changing any one of the components will shift the balance one way (increased pressure required) or the other (higher pedal forces required) to generate the same clamp load. Remember, bigger calipers don't create any more stopping power and they do not decrease stopping distance; they just generate higher clamp loads for a given pressure input.

One final caliper note of interest: you may have heard the terms “fixed caliper” (indicating that the caliper body is bolted directly to the suspension upright) and “floating caliper” (indicating that the caliper body is free to float on sliding guide pins). Although there are pros and cons associated with each type, there is not enough room in this article to dig into the details of their design differences. For now, let it suffice to say that the above math works out the same for either design.

So, in our example the brake pedal, master cylinder, and caliper have amplified the original 90 pounds of driver input to over 2,000 pounds—an increase of more than 22 times—but we still haven't stopped the truck (keep thinking traction, traction, traction).

### THE BRAKE PADS

This part might surprise some and offend others, but there is a big misconception that changing brake pad material will magically decrease your stopping distances. In fact, you may have even seen published data which attempts to correlate stopping distance to friction coefficient. Although it may appear that there is a relationship between the two, there really isn't. Here's why.

The brake pads have the responsibility of squeezing on the rotor (a big steel disc which is mechanically attached to the road wheel) with the clamping force generated by the caliper. There is a lot of

black magic surrounding the material composition and formulation of the friction puck, but what really matters is the effective coefficient of friction between the brake pad and the rotor face.

By knowing the clamp load generated by the caliper and the coefficient of friction between the pad and rotor, one can calculate the force acting upon the rotor. In this particular example, let's assume the brake pads have a coefficient of friction of 0.45 when pressed against the rotor face. The rotor output force is equal to the clamp force multiplied by the coefficient of friction (which is then doubled because of the floating design of the caliper)—or in this case  $\{2,068 \text{ pounds} \times 0.45 \times 2\} = 1,861 \text{ pounds}$  (see Figure 5). Nothing magical about it.

By increasing the coefficient of friction of the brake pads, the results are the same as increasing the caliper piston diameter—higher forces will be generated for the same input. But as before, this force alone is not what stops the truck (remember: traction, traction, traction). So why change brake pad materials in the first place? Because increasing the coefficient of friction can allow for the use of smaller/fewer caliper pistons and/or will reduce the amount of pedal force that the driver needs to apply in order to generate a given rotor output force.

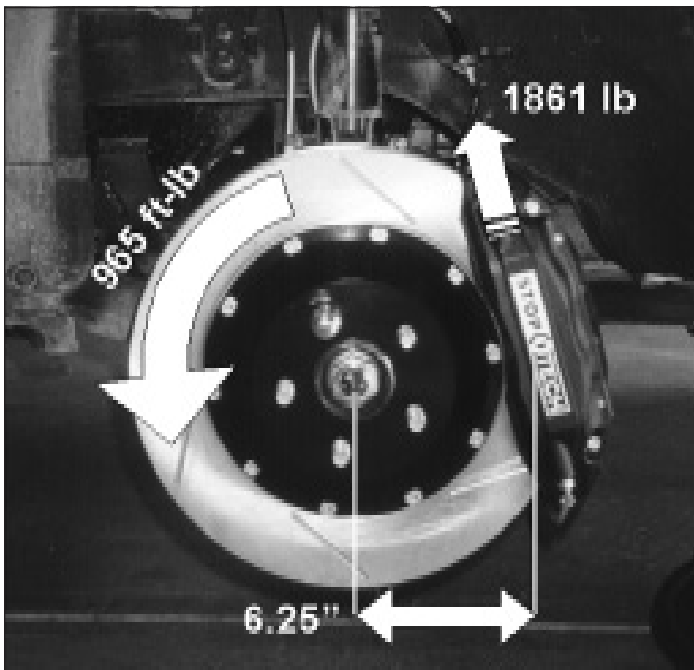

Figure 5 – The brake corner in action

That's about it from a design standpoint; however, there is a final point to consider—heat! In the example above, the rotor output force was calculated assuming that the coefficient of friction between the brake pad and the rotor was constant, but in the real world this is not the case. As the temperature of the components change, the physical properties of those components changes, and in the case of the brake pads, the coefficient of friction can change dramatically! While pads might have a coefficient of 0.45 around town, after a few trips down the mountain and fully loaded, the coefficient can drop to below 0.10, a condition commonly known as brake fade. (Note: this should not be confused with brake fluid fade which results from water in the brake fluid turning to vapor at high temperatures.) If

you have ever experienced brake fade firsthand, you know this can be kind of, well, unsettling to say the least.

So, back to the black art of friction materials. While a coefficient of friction number is a nice data point to consider when modifying a braking system, what is even more important is the ability of the material to maintain that coefficient under a variety of temperatures brought on by driving and towing conditions. Brake pads with radical changes in coefficient over their operating range are not your best friend. Be sure to select one that remains relatively stable under the operating conditions you are expecting, but don't expect any shorter stopping distances, because, the brake pads don't stop the truck!

## THE ROTOR

The rotor actually stops the truck—just kidding! Like the other parts of the system mentioned so far, the rotor does not stop the truck; however, unlike the other braking system components, the rotor serves two purposes. In order of appearance, they are:

- 1) The rotor acts as the frictional interface for the brake pads. But because it is a spinning object, it reacts to the output force by absorbing the torque created. Any time a force is applied to a spinning object a torque is generated. In this case, if we assume the force to act at a point midway across the rotor face (6.2" from the center of rotation in our example) then the torque is equal to about 964 ft-lb.  $\{1,861 \text{ pounds} \times 6.2" \div 12 \text{ inches per foot}\}$ . Take a second look back at Figure 5 to follow along.
- 2) The rotor must also absorb the heat generated by the rubbing of the brake pads against the rotor face.

In the case of item (2) above, the rotor dissipates the heat generated by warming the air surrounding the rotor (this is why brake cooling ducts are so useful), but where does the torque go? The calculated 964 ft-lb. sure is a lot of torque (most diesel owners would appreciate those kinds of torque numbers), and it has to go somewhere. . .

## THE WHEELS AND TIRES

Time to get down to business—and time to stop the truck. Because the wheel and tire are mechanically bolted to the rotor, the torque is transferred through the whole assembly—rotor to hub, hub to wheel, and wheel to tire. And now, the moment we have all been waiting for...

It is the traction between the tire and the road that reacts to this torque, generating a force between the tire and the road that will oppose the motion of the truck. The math looks just like the equation to calculate the torque in the rotor, but in reverse. Crunching the numbers based on a 275/35R17 race tire with a rolling radius of 12.2 inches (there go those race car numbers sneaking back into a TDR article again) shows that a force of 942 pounds is generated between the tire and road, opposing the motion of the vehicle. Ladies and gentlemen, this is what stops the truck—**not** the brake pads, **not** the rotors, **not** the cool stainless steel brake lines—it's road reacting against the tire!



Now, in order to finish the article, all that is necessary is to add up all the forces (remember, there is a force acting on every tire with a brake) and run through a little more math. In case you haven't noticed, we engineers just love this math stuff!

### ADDING THE FORCES

As that famous guy Newton said, force = mass x acceleration { $F=MA$ }. Or stated another way, the acceleration (or deceleration as the case may be) of an object will be equal to the sum of all of the forces acting on the object divided by the weight of the object.

Before we can sum up all the forces, there is one last little important fact to consider—the tire forces are not the same for the four corners of the truck. Due to the static weight distribution of the truck, the location of the center of gravity of the truck, and the effects of dynamic weight transfer under braking (just to name a few), the rear brakes are designed to generate much smaller forces than the forces generated by the front brakes. For the sake of argument, and for this exercise, we'll say the split is 80% front and 20% rear, but the actual distribution is dependent on the specific vehicle configuration.

So, if each front tire generates 942 pounds of force, then we can calculate that each rear tire generates 20% of that, or 188 pounds. Adding up the four corners now gives us a total of 2260 pounds of force acting on the vehicle between the four tires and the road.

Rearranging Newton's homerun mentioned above, { $\text{decel} = \text{force} \div \text{weight}$ }, we can calculate that the total deceleration of the vehicle is about 0.85g's, or { $2260 \text{ pounds force} \div 2640 \text{ pounds weight}$ }. Easy, right? Figure 6 wraps it all up for us.

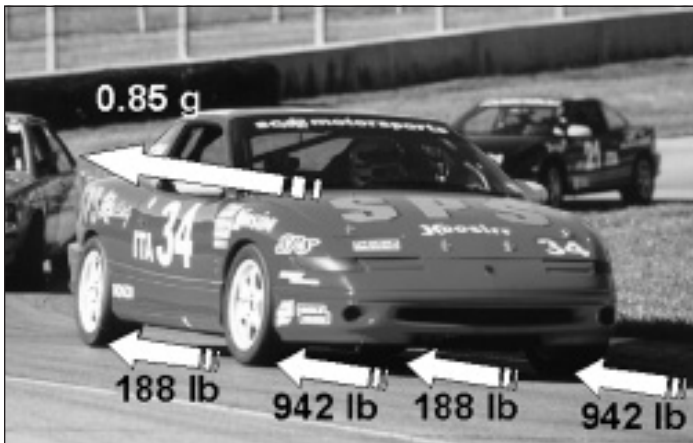

Figure 6 – Look! A real race car!

Doing a little backwards math here that TDR readers will appreciate, we can calculate that if our vehicle is generating 2260 pounds of force through tires that are 24.2 inches tall, our braking system has created 2223 foot-pounds of torque. Can that possibly be right?

While this may sound like an unreasonable number, these torque levels are commonplace in braking system design and analysis. It takes torque to accelerate, but it also takes torque to decelerate. Consider that a typical unloaded truck can easily stop from 60mph in well under four seconds on dry pavement (assuming adequate

traction). In contrast, just imagine how much engine torque it would take to accelerate your truck from rest to 60mph in that same sub-four second window. Yes, there is a transmission and final drive reduction in the acceleration equation, but in nearly every case factory braking systems are designed to generate more torque than the factory powertrain is capable of producing.

Brake guys chuckle to themselves when engine guys brag about their torque output.

### CALCULATING THE DISTANCE

Okay, last equation of the day. Given a vehicle speed of, say, 100 miles per hour, and the deceleration level from above, we can now calculate the distance required to bring the truck to a stop. But, in order to make sure the answer comes out in feet we first need to juggle the numbers around a little bit:

100 miles per hour = 147 feet per second  
0.85g's = 27.0 feet per second per second

Apply the equation for stopping distance { $\text{distance} = (\text{initial speed})^2 \div (\text{deceleration} \times 2)$ } and lo and behold, exactly 400 feet are required to bring this truck down to a stop from 100 miles per hour (given our original pedal input force of 90 pounds). Tah dah! The truck is now stopped.

### LIMITING FACTORS

From this example, it would appear that we might be able to make the truck stop in a shorter distance. Let's investigate these two options further:

- Change the brake system to increase the force between the tire and the road for a given pedal input force
- Press on the brake pedal harder

These two changes will shorten the truck stopping distances for sure, but only up to a point. Anyone who has ever driven on an icy road will get this right away. As the brake pedal force is gradually increased, the deceleration rate will also increase **until the point at which the tires run out of traction and lock up**. Beyond this point, additional force applied to the brake pedal does nothing more than make the driver's leg sore. The vehicle will continue to decelerate at the rate governed by the traction between the tires and the road. As you know, the traction of a given tire on ice is much lower than the traction of that same tire on dry pavement. This is exactly why stopping distances are longer on slippery surfaces.

You can take this one to the bank. Regardless of your huge rotor diameter, brake pedal ratio, magic brake pad material, or number of pistons in the calipers, your maximum deceleration is limited **every time** by the tire-to-road interface. That is the point of this whole article. Your brakes do not stop your truck. Your tires stop the truck. So while changes to different parts of the brake system may affect certain characteristics or traits of the system behavior, using better tires is ultimately the only sure-fire method of decreasing stopping distances.

---

## SO WHY WOULD ANYONE WANT TO MODIFY THEIR BRAKES?

So, if changing braking system components does not provide shorter stopping distances, why even consider changes in the first place? Why not just leave the brakes alone and buy new tires? Well, as we have implied earlier in this article, making changes to your braking system can have a very real, very significant impact on four other areas of brake system performance (other than stopping distance).

- **Driver tuning.** Modifying your brake system component sizing (brake pedal ratio, master cylinder piston diameter, caliper piston diameter, rotor diameter) can be performed to adjust the feel of the truck to suit the driver's tastes. Some drivers prefer a high, hard pedal while others prefer a longer stroke. In this regard, tuning your brakes is a lot like tuning your shocks—every driver likes something different, and there is no right answer within certain functional limits. These components can be adjusted in small steps to achieve a feel that the driver prefers.
- **Thermal control.** Modifying your brake system mass (rotor weight) can be utilized if there is a thermal concern in the braking system. If your brakes work consistently under your driving conditions, then adding size to the braking system will accomplish nothing more than increasing the weight of your vehicle. But if high temperatures are having an adverse effect on braking system performance, or other components in general (wheel bearings for example), then you should consider “super-sizing”. Naturally, other constraints (wheel diameter, for example) may make super-sizing impossible, but adding rotor weight is the best way known to reduce brake temperatures. Figure 7 shows just how far one car go!
- **Temperature sensitivity.** Modifying your brakes to address the presence of high temperatures (brake pad material and brake fluid composition) should be considered if your thermal concerns cannot be resolved by super-sizing. This is really just a Band-Aid for undersized systems. One might argue that it is more cost-effective to install better brake pads and brake fluid than it would be to upsize the rotors, but all that heat still needs to go somewhere—and more often than not it will find the next weak link in the system.
- **Compliance.** Any changes that you can make to your braking system to reduce compliance will increase the overall efficiency of the system—improving pedal feel, wear, and stop-to-stop consistency. Think of it as balancing and blueprinting your braking system.



Figure 7 – Filling the wheel with brake hardware

In summary, brake system modifications have their place to help make your ride more consistent, predictable, and user-friendly; however, if your ultimate goal is to decrease your stopping distance, look no further than the four, palm-sized patches of rubber connecting your ride to the ground.

**James Walker**  
TDR Writer

### ABOUT THE AUTHOR

James Walker, Jr. of scR motorsports races a 1992 Saturn SC in the SCCA's ITA class. With a degree in vehicle dynamics, his brake systems background has included tours of duty with Delphi, TRW, GM, Bosch, and the Ford Motor Company. And, when spare time allows, he serves as a consultant to STOPTECH, an industry leader in high-performance braking systems. To find out more about James and his team, visit their website at [www.teamscR.com](http://www.teamscR.com).

## BRAKE PAD SELECTION

by James Walker

*In Issue 40 we asked engineer-writer James Walker to adapt his article on brake systems for the TOR audience. I had found James' original in Grassroots Motorsports and was impressed by his common-sense writing style. As an introduction to this issue's "Brake Pad Selection" I'll pull a quote from his Issue 40 article, "modifying our brakes to address the presence of high temperatures (brake pad material and brake fluid composition) should be considered if your thermal concerns cannot be addressed by super-sizing." Super-sizing sounds expensive, so let's hear what James has to say about brake pad selection.*

In Issue 40 we learned that as brake pedal force (how hard the driver is pushing the pedal) is increased, the truck's deceleration rate will also increase (the truck will slow down more) until the point at which the tires run out of traction and lock up (or go into ABS if so equipped). Beyond this point, additional force applied to the brake pedal does nothing more than make the driver's leg sore. Tire-to-road traction was discovered to be the limiting factor for stopping distance, and here in Issue 41 we are back to tell you that fact hasn't changed.

At the same time, we also learned that there were several other benefits to changing brake system characteristics which could benefit the typical TDR reader. Even though race-bred big brake kits are probably beyond the scope of most of the audience, tangible improvements can still be had in the areas of driver tuning, temperature sensitivity, and compliance. Because we don't want this magazine to turn into a 200-page essay on brake system design, for now let's just look at the most common upgrade of all: the brake pads.

## BRAKE PADS 101

One of the single most common brake upgrades is the replacement of factory pads with premium, high-performance, or heavy-duty brake pads. However, because there are no industry standards for what constitutes a "premium," "high-performance," or "heavy-duty" brake pad, the consumer is best advised to do a bit of research beforehand to determine if the four pieces of friction material in the cardboard box (Figure 1) are suitable for their purpose.



Figure 1 - Typical Brake Pads

### Driver Tuning

One of the brake pad's most significant characteristics is its effective coefficient of friction. In general, brake pads from the factory are sold with a relatively low coefficient of friction (typically in the 0.30 to 0.35 range) in order to make the brakes as noise-free as possible. While there are about a bazillion other reasons why this range is so common, let's suffice it to say that in the aftermarket there are not as many restrictions or constraints placed on the friction material performance. It's basically a case of anything goes, and as a result you can buy pads with just about any friction level you desire.

Increasing the coefficient of friction just a small amount can cause the brake system feel to change dramatically. For example, if a factory brake pad with a coefficient of 0.30 was replaced with an aftermarket brake pad with a coefficient of OAO, the result would be the same as if the driver pressed on the brake pedal 33% harder! Because the relationship of driver force-to-deceleration is generally linear, any change in friction level (on a percentage basis) will directly result in an equal level of increased deceleration. In other words, the driver now has to hit the pedal with less force to achieve the same level of deceleration so the truck feels like it is stopping faster. This is typically regarded as a good thing.

Unfortunately, like most things in life nothing is free. Even though this sounds like a good deal, as soon as the friction level is changed other brake system characteristics can be impacted inadvertently. ABS calibrations, brake balance, noise, wear, dust, and roughness are just some of the possible areas of concern. Buyer beware, the only brake pad which has been certified to work in harmony with your truck is the pad that came from the factory! Increased friction may be on your wish list, but be ready to deal with these side effects should they arise.



## Temperature Sensitivity

For those owners who do a significant amount of towing or heavy hauling, temperature sensitivity might be the number-one priority. Increased friction levels are great, but if the pad rapidly loses friction as the temperatures go up (a phenomenon known as brake fade), then all of a sudden the truck doesn't want to stop. This is typically regarded as a bad thing. What makes the issue even more complicated is that two brake pads with identical advertised friction levels may have completely different temperature sensitivity profiles (see Figure 2).

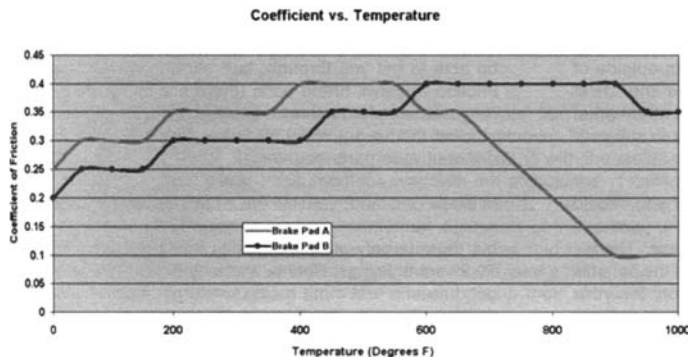

Figure 2 - Coefficient vs. Temperature

While the pads from the factory were chosen by the manufacturer to provide a certain amount of resistance to brake pad fade, there are many choices in the aftermarket which can tolerate even higher temperatures before the inevitable drop-off occurs. Keep in mind that like increasing the coefficient of friction, changing brake pad formulation to resist these higher temperatures will come with a penalty in some other area of performance. Compromise is the rule, and typically those pads with higher temperature thresholds will give up noise isolation, pad life, or cold temperature performance as a result. Note that not every high-temperature pad will degrade performance in all of these areas, but be prepared!

## Compliance

Believe it or not, brake pads are pretty soft and spongy objects. As a result, every time you step on the brake pedal, part of your leg effort is being used to squish the molecules of the brake pad material closer together instead of generating brake torque. While this is certainly not the most efficient of situations, it simply cannot be avoided.

That said, changing from brake pad A to brake pad B for driver tuning (friction level) or temperature sensitivity (fade resistance) can bring with it a change in the lining compressibility, which in turn can change the brake pedal feel. Those brake pads with more compressibility will generally exhibit a softer, spongier pedal while those with low compressibility will typically provide the driver with a more firm brake pedal.

Unfortunately, brake pads with the highest friction levels usually have the highest compressibility, so the pedal feel benefits of the higher friction levels can be masked by the compliance loss of the pad itself. Just the opposite can be true as well, so those brake pads with the lowest friction levels can provide the most firm pedals. Ironic, but that's the harsh reality of the situation.

## All of Those Other Things

Naturally, in addition to stopping the vehicle, everyone wants a brake pad that doesn't squeal, doesn't create piles of brake dust, doesn't pulsate, and lasts for 100,000 miles. Rest assured that if this miracle brake pad configuration was discovered today, every other brake pad manufacturer would be out of business tomorrow. Sadly this perfect brake pad does not exist, so we are forced to make educated decisions regarding our needs and trade-offs.

What it comes down to is this: your truck came from the factory with a brake pad designed and developed specifically for a certain set of operating conditions. If your vehicle usage is outside of that window, or if you simply want to enhance the OEM performance in some specific way, there are several aftermarket brake pad manufacturers ready to sell you a product to suit your needs.

However, before you spend your hard-earned dollar you should clearly define exactly what you are expecting from your purchase and what negative side effects you are willing to accept. There's no free lunch in brake pad land; but if you are aware of the benefits and trade-offs, you can make the best decision for your application. Make every attempt to find a vendor or manufacturer that can walk you through these decision-making steps, as they will know their product's strengths and weaknesses better than anybody.



How about super-sizing?  
Check out these StopTech racing brakes.



---

## Making the Best Decision

Unlike tire UTQG codes which make an attempt to characterize a tire's performance in several different areas (wet traction, temperature sensitivity, wear rate, and so on), no such information exists from the brake pad manufacturers. Short of a cryptic "edge code" which may or may not be available (and is, frankly, meaningless to the consumer), it's a classic case of buyer beware.

However, there are a few helpful hints and rules of thumb that can go a long way toward helping you make the best choice for your particular application. Note that this list is far from all-encompassing, but should get you well on your way toward making an informed purchase when your truck begins to squeal, shake, and s-s-h-h-u-u-d-d-d-e-e-r-r.

Stick with a name brand brake pad. While this may sound obvious, there are countless no-name products on the market that could compromise your brake system performance. Nobody can tell how well a brake pad will perform by looking in the box, so rely on the company whose name is printed on the side. In a pinch anything that fits may be able to get you through, but sticking with Performance Friction or Hawk brand pads (there are many more-these are just examples) will most likely result in a more consistent product than a set of \$9.99 Super Stoppers from the local discount auto parts counter.

In brake pad land, you still get what you pay for. Brake pad design, formulation, and manufacturing is not rocket science, but there is only so much quality that can be baked into a \$9.99 set of linings, lifetime warranty or not. There is a very good reason that most racing brake pads cost hundreds of dollars-the materials that provide consistent friction at high temperatures cost more than those that fall apart on lap three. These same materials are required in severe use towing and hauling applications, so don't expect to pay any less!

Listen to recommendations from people using their trucks the same way you do. Word-of-mouth advertising is still one of the best ways to publicize a product known, and those brake pads with extreme performance, either good or bad, are certainly going to get noticed. Just because everyone is using a set of particular pads doesn't mean it's the best choice for you, but it sure can be a great place to start.

Don't be afraid to call the brake pad manufacturer, dealer, or distributor directly to get a pad recommendation. Typically a manufacturer will have several pad compounds to choose from, and the best fit to your application may not be obvious. Share all of your expectations and requirements and see what they have to offer. Naturally you will have to temper their recommendation with the knowledge that they are also trying to sell you their product, but it never hurts to ask.

In closing, beware of the brake pad that claims to do everything well. More often than not, these brake pads are made of snake oil.

Happy stopping!

**James Walker**  
TDR Writer

## TWENTY-ONE BRAKE QUESTIONS

by James Walker

Our two-part series in Issues 39 and 40 on brake systems and brake pads has generated many inquiries. I took time to consolidate the questions and then sent them to our resident brake guru, James Walker, Jr., for his response.

With issues 40 and 41 in your library and the following “Twenty-one Brake Questions” article in hand, I am hopeful that we have given the brake topic sufficient coverage. Read on and I think you will agree!

### 1. What causes my rotors to warp? Is it because I am driving my truck too hard?

In 99% of all cases (not a scientific number, but close enough), warped rotors are not physically warped at all. The vibration and pulsation that is felt in the steering wheel, brake pedal, and floorboard is almost always caused by rotor disc thickness variation, or TV.

TV is generally created in one of two ways. Most commonly, when the truck is parked for extended periods of time, a layer of corrosion (rust) can form between the brake pad face and the rotor. When the truck is then moved, there is a slight high spot on the rotor face which will then wear at a different rate than the surrounding material (see Figure 1). Over time, this condition will only get worse until you feel it in your foot.

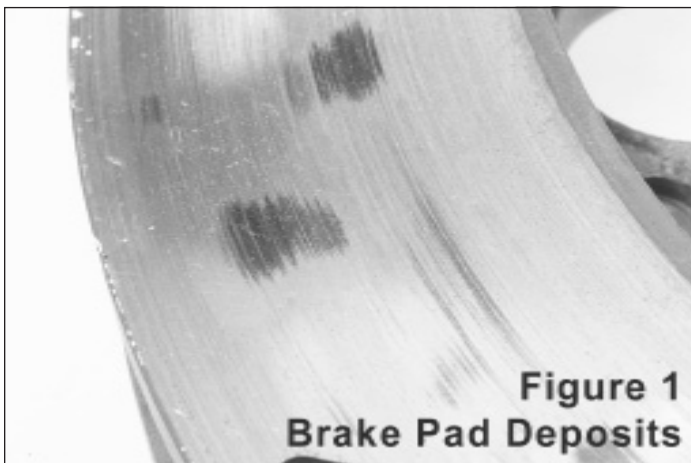

TV can also be generated through overheating of the rotor. When the rotor gets really, really warm, it will actually develop isolated spots which are hotter than the surrounding material. These hot spots will also accelerate wear locally, creating a thick and thin pattern on the rotor face. Again, this will only get worse with time until the TV is felt by the driver and his (or her, as the case may be) passengers.

### 2. Will changing my brake pads reduce the tendency to generate rotor TV?

Actually, yes. If your truck is typically left outside in the weather for extended periods of time, it might be best to select a non-metallic brake pad. These brake pads reduce the tendency to generate corrosion between the pad and the rotor. Over time, this may reduce the generation of TV.

However, it's not a free lunch. Non-metallic pads also have the tendency to be less-suited for towing or severe duty applications. So it's a trade-off.

### 3. When I have my front end off the ground and spin the tires I feel the brakes dragging more than I expect. When I lift the rear end off the ground and do the same thing, I do not feel nearly as much drag. Is this normal?

Rest assured, this is completely normal. By design, disc brakes (see Figure 2) will always have a slight amount of drag.

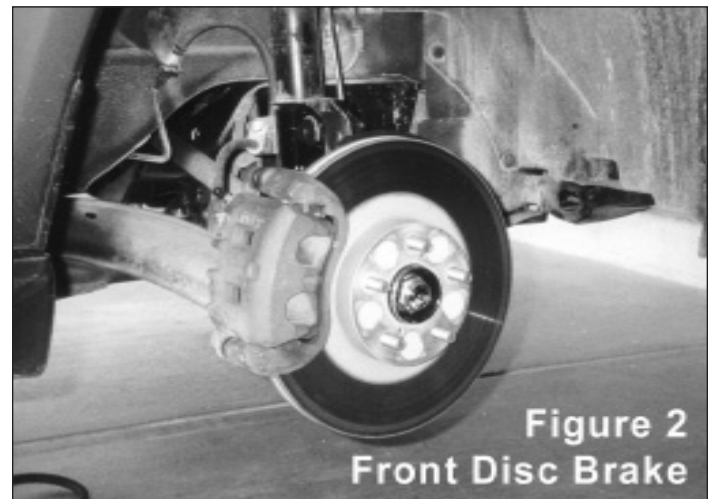

Disc brake calipers employ a square sectioned piston seal to pull the caliper piston back into its bore when the brake pedal is released. However, the seals are designed so that they don't pull the pistons back quite so far that the brake pedal feels mushy when you need it the next time. This compromise in design leads to brakes that do exhibit a small amount of drag when released, but minimal pedal dead travel when applied.

Drum brakes (as found on the rear of your Ram), on the other hand, use real-live retraction springs to pull the brake shoes completely off the drums when released. This leads to much less running drag, and because the rear hydraulic system is smaller than the front, the trade-off in pedal dead travel is acceptable.

**4. I'm putting new brake pads on my truck and would like to know how they should be "broken-in." Is there a defined procedure I should be following?**

On street-driven vehicles (as opposed to race cars), a "burnish" procedure will go a long way toward ensuring good system performance. In short, running through a series of medium deceleration stops from approximately 60mph to 10mph (allowing time for the parts to cool inbetween to avoid pad fade) should do the trick. This procedure basically allows the brake pad and rotor wear surfaces to get to know each other so that maximum contact is made between the two.

Certain race car-type brake pads require a procedure known as "bedding-in," in which the pads are allowed to get hot enough during the break-in procedure to leave a uniform deposit layer on the rotor face. However, for street-driven vehicles this is not usually necessary or recommended.

**5. How do I know when to change the brake fluid in my truck? It looks kind of brown and murky through the reservoir bottle.**

This is a tough one to answer. Here in the US, most auto manufacturers do not specify a replacement interval for brake fluid (see Figure 3), so consumers are left to their own devices. Not surprisingly, the default action has become to never touch the stuff even though regular replacement has real benefits!

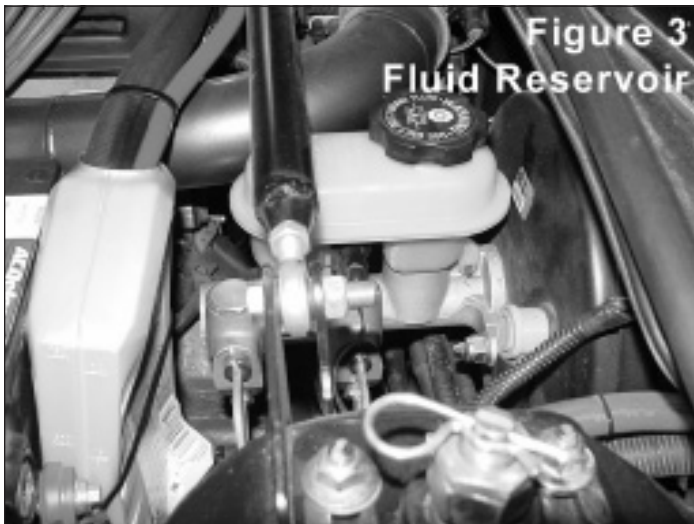

As brake fluid ages it absorbs water. Unfortunately, when the water get sucked up, it lowers the boiling point of the fluid, and it doesn't take too long until the resulting mixture has a boiling point much lower than when it was new.

So why is this important? During severe towing or hauling (or even high-speed driving) the brake fluid can see temperatures of 300°F or even more! When you consider that the government requirement for new DOT 3 fluid is only about 400°F, it doesn't take much time until the fluid degrades to the point where it can be subject to boiling in the line!

As boiling brake fluid doesn't do much to help slow your truck, your best defense is to change your brake fluid on a yearly basis if you consistently get the brakes toasty warm. If low-speed around town driving is more your style, a longer interval is probably just fine, but fresh brake fluid is cheap insurance.

**6. Are there any differences between brake fluids? Should I be concerned about mixing different types or different brands?**

Like motor oils, most DOT 3 and DOT 4 brake fluids are compatible with one another and should mix without any problem. However, silicone-based DOT 5 fluids are absolutely not compatible with any DOT 3 or DOT 4 brake fluids and really shouldn't be considered for your application unless your vehicle came with DOT 5 in the first place.

That said, DOT 4 fluids are held to a higher government standard than DOT 3 fluids. In general, the DOT 4 fluids will have higher boiling points and will resist water absorption a bit longer than the DOT 3 fluids, but the down side is that DOT 4 fluids should be replaced on a more regular basis than DOT 3 fluids. Ironically, the very compounds that help to raise their boiling points make them wear out more quickly. Nothing is ever free, is it?

**7. How about DOT 5.1 fluid? Is it better than DOT 3 or DOT 4 fluids?**

DOT 5.1 fluids should mix just fine with DOT 3 and DOT 4 fluids, as they too are made from the same base materials. However, DOT 5.1 fluids (which perform to much higher levels than DOT 3 or DOT 4 fluids) are usually overkill for street-driven vehicles.

**8. I'm thinking about installing cross-drilled rotors. What kind of brake system improvements should I notice?**

Well, unless your truck is using brake pads from the 40s and 50s, not a whole lot. Rotors were first drilled because early brake pad materials gave off gasses when heated to racing temperatures—a process known as "gassing out." These gasses then formed a thin layer between the brake pad face and the rotor, acting as a lubricant and effectively lowering the coefficient of friction. The holes were implemented to give the gasses somewhere to go. It was an effective solution, but today's friction materials do not exhibit the same level of gassing out phenomenon as the early pads.

For this reason, the holes have carried over more as a design feature than as a performance feature. Contrary to popular belief, they don't lower temperatures much at all. In fact, by removing weight from the rotor, the temperatures can actually increase a little under certain conditions. They create stress risers allowing the rotor to crack sooner, and make a mess of brake pads—sort of like a cheese grater rubbing against them at every stop.

However, they do look cool and can arguably improve initial brake pad bite. If those are reasonable trade-offs, go for it; but don't expect shorter stopping distances or reduced brake temperatures regardless of the marketing hype.

**9. I'm thinking about installing slotted rotors. What kind of brake system improvements should I notice?**

Cutting thin slots (usually only a few mm deep) across the face of the rotor can actually help to clean the face of the brake pads over time. This helps to reduce the "glazing" often found during high-temperature use which can eventually lower the coefficient of friction. While there may still be a small concern over creating stress risers in the face of the rotor, if the slots are shallow and cut properly, the trade-off appears to be worth the benefit.

There are as many slotting designs and patterns as there are brake manufacturers these days (see Figure 4), but the differences are primarily cosmetic. More slots equal more leading edges, but the effect is the same.

As a final note, expect extra dusting and shorter life from your brake pads if you run slotted rotors on the street!

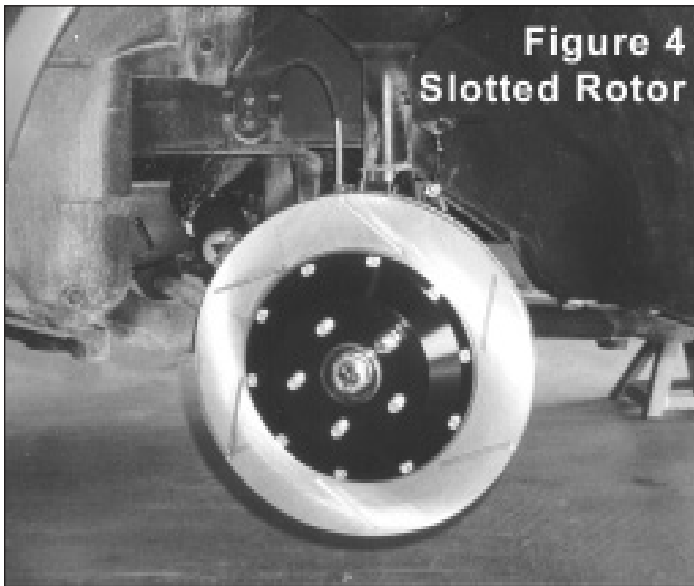

**10. I have noticed that my rotors have a bunch of grooves on the outboard and inboard faces. Is this a bad thing?**

In general, shallow grooves on the face of a rotor are not terminal. They can be caused by debris caught between the pad and the rotor, brief overheating of the rotor face, or voids in the brake pad surface. It's just a natural thing, but be wary of deep scoring or pitting—both are valid reasons for rotor replacement.

**11. I'm thinking about installing stainless steel braided brake lines. Is this a good idea?**

When you get down to it, the only difference between the cool looking stainless steel brake lines and the stock flexible lines are the outer covering (stainless braid versus rubber). The tube that the brake fluid passes through is still nylon, and the fittings at either end are just hollow bolts.

What the stainless lines do provide is increased protection from flying roadway debris and slightly less compliance (expansion) when brake fluid pressure is generated (see Figure 5).



In some applications, this reduction in compliance can be perceived by the driver as a "firmer" pedal, but every application is different (and usually a function of the age of the original lines at the time of replacement). On a big diesel running factory Hydroboost, the improvement in pedal feel will probably be pretty small, but may be noticeable. Don't set your expectations too high and you probably will not be disappointed.

**12. How many times can I turn my rotors before they need to be replaced?**

When determining whether a rotor should be turned or replaced the important factor is not how many times it has been turned in the past, but rather how thick the rotor is in the first place.

Nearly every rotor available (both from the factory and over the counter) has a minimum thickness number cast into the back side of the rotor hat section. This number is the minimum thickness recommended by the manufacturer after the rotor has been turned, not before.

As a rule of thumb, turning a well-used rotor usually results in taking off at least 0.030" to 0.050" of material per side, so be sure to measure beforehand to see if the rotor is even a candidate for turning. If you don't have the tools necessary to measure and make the determination yourself, most auto parts stores will be happy to check them for you.

**13. Are there minimum thickness number for drums as well?**

As with rotors, most drums also have a cast-in dimension for thickness after turning. However, because material is removed from the inside diameter of the drum, the number given is a maximum dimension not to be exceeded after turning.



**14. What's the difference between a "fixed" caliper and a "floating" caliper? Is one type better than the other?**

As the name implies, a fixed caliper (see Figure 6) is rigidly attached to some part of the vehicle suspension (the axle housing, a front knuckle, etc.). Because the caliper body is not free to move relative to the rest of the braking system (the rotor in this case), these calipers have pistons on both the inboard and outboard rotor faces, allowing a clamping force to be generated when pressure is applied.



**Figure 6  
Fixed Caliper**

In the floating set-up, an anchor bracket is mounted to the vehicle suspension and the caliper body is free to float axially in the bracket on a pair of slider pins (see Figure 7). This design allows for pistons on the inboard side of the caliper body only. The rest of the clamping force is generated by the reaction force on the caliper fingers (the outboard side of the caliper body) which are pulled against the rotor face as the pistons on the inner face extend outward.

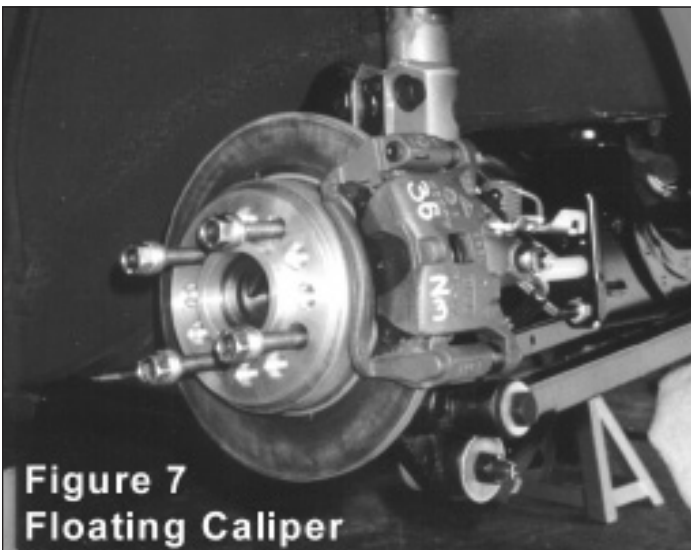

**Figure 7  
Floating Caliper**

While the fixed type caliper is more efficient in general, floating calipers typically take up less space and are cheaper to manufacture. For this reason, almost every large-volume production truck and car on the road today (including your Ram) utilizes floating calipers.

**15. What is brake pad fade?**

Pad fade (or lining fade) occurs when the materials which make up the brake pad actually begin to vaporize and boil to the pad surface. These gasses then form a nice lubricating layer between the brake pad and the rotor face, effectively reducing the coefficient of friction between the two to near zero. What this means to the driver is that the pedal is quite firm and high in its travel, but regardless of how hard the pedal is pushed, the truck just won't stop. This is generally not considered to be a good thing.

So why does pad fade occur? Heat. All brake pads have a thermal point at which they create these gasses, some naturally higher than others. Your first clue that you are approaching pad fade will be the smell of the pads letting off their gasses. Your next clue will be the inability to stop your truck. Pay attention to the first clue.

**16. What is brake fluid fade? Is it different from brake pad fade?**

Fluid fade also occurs when heat gets out of control, but in this case the brake fluid itself will actually boil in the lines. Because brake fluid as a vapor is much more compressible than brake fluid as a liquid, the driver will get the sensation of the pedal being quite soft and spongy. In extreme cases, the pedal can fall almost to the floor before the truck begins to slow. This also is highly undesirable.

Unlike with pad fade, there are no early warning signs to the driver that things are going downhill fast (no pun intended). However, if fluid fade is encountered it can usually be remedied on the fly by quickly pumping the brake pedal to force more fluid into the system. This should not be mistaken for a long-term solution, but in the heat of the moment (again, no pun intended) it might just save you and your truck.

**17. So how can I avoid both types of fade?**

The best way to avoid pad fade is to invest in brake pads which can take the heat. Fluid fade can be avoided by using a high-quality brake fluid and replacing it on a regular basis. However, in both cases heat is the enemy, so slowing down or reducing your load is always another viable short-term solution.

---

**18. What is the process for changing my brake fluid? Is it different than what I would do to bleed my brakes?**

This procedure works for both bleeding the brakes and for completely replacing the fluid. The only difference is in the number of times the process is repeated.

1. Begin at the corner farthest from the driver and proceed in order toward the driver. (Right rear, left rear, right front, left front.)
2. Locate the bleeder screw at the rear of the caliper body (or drum brake wheel cylinder). Remove the rubber cap from the bleeder screw. Don't lose it!
3. Place a box-end wrench over the bleeder screw hex. An offset wrench works best since it allows the most room for movement.
4. Place one end of a clear plastic hose over the nipple of the bleeder screw. Make sure it is a tight fit to avoid leaks.
5. Place the other end of the hose into a clear disposable bottle.
6. Place the bottle on top of the caliper body or drum assembly. Hold the bottle with one hand and grasp the wrench with the other hand.
7. Instruct your assistant sitting in the truck to "apply." The assistant should pump the brake pedal three times, hold the pedal down firmly, and respond with "applied." Instruct the assistant not to release the brakes until told to do so.
8. Loosen the bleeder screw with a brief  $\frac{1}{4}$  turn to release fluid into the waste line. The screw only needs to be open for one second or less. (The brake pedal will "fall" to the floor as the bleeder screw is opened. Again, instruct the assistant in advance not to release the brakes until instructed to do so.)
9. Close the bleeder screw by tightening it gently. Note that one does not need to pull on the wrench with ridiculous force. Usually just a quick tug will do.
10. Instruct the assistant to "release" the brakes. Note: do NOT release the brake pedal while the bleeder screw is open, as this will suck air back into the system!
11. The assistant should respond with "released."
12. Inspect the fluid within the waste line for air bubbles.
13. Continue the bleeding process (steps 11 through 16) until air bubbles are no longer present. Be sure to check the brake fluid level in the reservoir after bleeding each wheel. Add fluid as necessary to keep the level at or near the MAX marking. (Typically, one repeats this process 5-10 times per wheel when doing a 'standard' bleed, more if the fluid is being completely replaced.)

14. Move systematically toward the driver—right rear, left rear, right front, left front—repeating the bleeding process at each corner (see Figure 8). Be sure to keep a watchful eye on the brake fluid reservoir. Keep it full!



15. When all four corners have been bled, spray the bleeder screw (and any other parts that were moistened with spilled or dripped brake fluid) with brake cleaner and wipe dry with a clean rag. (Leaving the area clean and dry will make it easier to spot leaks through visual inspection later!) Try to avoid spraying the brake cleaner directly on any parts made of rubber or plastic, as the cleaner can make these parts brittle after repeated exposure.
  16. Test the brake pedal for a firm feel. (Bleeding the brakes will not necessarily cure a "soft" or "mushy" pedal—since pad taper and compliance elsewhere within the system can contribute to a soft pedal. But the pedal should not be any worse than it was prior to the bleeding procedure.)
  17. Be sure to inspect the bleeder screws and other fittings for signs of leakage. Correct as necessary.
  18. Properly dispose of the used waste fluid as you would dispose of used motor oil. Important: used brake fluid should NEVER be poured back into the master cylinder reservoir. Dispose of the fluid as you would motor oil.
- 19. If my brake fluid is below the MAX mark on the fluid reservoir, should I have it topped off?**

---

Usually not. Your brake system is designed so that as the brake pads wear, fluid stored in the reservoir is used to backfill the space left by the worn out pad material. When the next time comes to replace the pads, the fluid is then pushed back into the reservoir to start the cycle all over again.

The only time that fluid will actually leave the hydraulic system is if there is an external leak. This too will make the fluid in the reservoir drop, but the right answer is not to keep filling the fluid—you should find the leak and fix it immediately!

If you accidentally top off the fluid when the pads are worn out, or if your friendly service tech does it for you without knowing better, be careful to drain some of the fluid out of the system before replacing your brake pads. If you try to push the pistons back into the calipers to make room for the new pads, you may end up forcing all of the extra fluid out of the reservoir and down your firewall.

## **20. What can I do to my braking system to shorten my stopping distances?**

Remember back from our article in Issue 40—the traction between the tire and the road is the limiting factor in determining your truck's best stopping distance (see Figure 9). Making changes to any part of the braking system may reduce how hard you need to press on the brake pedal to get there, but ultimately it's the tire-to-road interface that governs the relationship.

If you want the shortest distances possible, buy the best tires you can. It's really that simple.



## **21. Why are there twenty-one questions in this article?**

Because everyone writes up a “Twenty Questions” article at some point. We just wanted to go one better.

**James Walker, Jr.**  
TDR Writer

---

## **BRAKE FLUID EXPOSÉ**

### **Everything You Always Wanted to Know About Brake Fluid (And are probably still afraid to ask)**

by James Walker

Without a doubt, changing brake fluid is at the absolute bottom of most owners' lists of "fun things to do with their trucks." Unfortunately, this mystery fluid is also one of the most vital components of all of your truck's safety systems, yet it can be neglected for years and years and years at a time. Heck, there are some people who would not change their fluid for the life of their truck without even batting an eye.

If you are one of these people, don't worry—help has arrived. Here is everything you will ever need to know about the very lifeblood of your truck's braking system. If you are not itching to run to the garage by the time you are done reading, you might want to check your pulse.

Okay, maybe that comment about checking your pulse was an overstatement, but you get the idea . . .

#### **What exactly does brake fluid do?**

Brake fluid's sole function is to transmit the pressure generated in the brake master cylinder to the four wheel brake assemblies. At the wheel ends, this pressurized fluid energy is ultimately translated into brake torque through another set of piston-based devices—calipers in the case of disc brakes or wheel cylinders in the case of drum brakes.

Now, while that may sound simple and straightforward, one needs to remember the various demands placed on the fluid itself. Just to name a few:

- The fluid must not solidify (freeze)
- The fluid must not vaporize (boil or fade)
- The fluid must be compatible with rubber seals
- The fluid must not be excessively compressible

#### **Temperature extremes**

Because real-world temperatures in North America routinely fall below -40F (and even colder in extreme locations), we have an idea of just how low the freezing point must be if we also want to add in a safety factor. Realistically, brake fluid itself has such a low freezing point that this limit is rarely, if ever, a concern.

High temperature performance, however, is a completely different animal. Not only does the fluid need to be robust to high ambient temperatures (130F and higher in Death Valley, for example), but one also needs to consider that the brakes themselves generate a significant amount of heat during operation. Quite frankly, Death Valley looks like an icebox in comparison.

During heavy driving, hauling, or towing, it is not uncommon to see brake pad and rotor temperatures in excess of 800F. While not all of that heat is inflicted on the caliper, the brake fluid inside can easily experience temperatures in the 300F-400F range with prolonged exposure. Yikes!

Fortunately for us, brake fluid manufacturers have found a way to formulate brake fluids that meet these extreme operating conditions. Unfortunately, these very same fluids have a skeleton in the closet...

#### **Water: the silent, wet enemy**

DOT 3, DOT 4, and DOT 5.1 brake fluids (more on these terms later) are based on glycol ether-based stocks, and as a result are hygroscopic in nature. In plain English, they absorb water like there is no tomorrow. (Conspicuous by its absence from the list above is DOT 5 fluid. Unlike DOT 3, 4, and 5.1, DOT 5 fluid does not naturally absorb any water whatsoever. More on this later.)

When brand new, common brake fluids can have boiling points of well over 400F without really even breaking a sweat. However, if even a minute level of water is adsorbed into the fluid (less than 5% of the brake fluid volume, for example), the boiling point can plummet to less than half of the value when new. For this reason, brake fluids have two advertised boiling points—dry (new) and wet (used).

This is also the reason that brake fluid comes in sealed containers. Once the seal is broken, the irreversible process of water absorption begins. Note also that once you open a new container of fluid you should either use the entire contents or discard the remaining portion. Brake fluid left on the shelf for a few years will degrade rapidly in boiling point performance. Figure 1 shows a typical seal.



**Figure 1 – A typical brake fluid container seal.**



### Why the heck do we use brake fluids that absorb water in the first place?

Believe it or not, one of a brake fluid's most vital characteristics is its ability to absorb water. Yes, you read that correctly—brake fluids absorb water by design and that is really a good thing.

What?

Whether we like it or not, water is everywhere and finds its way into everything. That's just the nature of the beast. Given enough time, even a brand-new sealed brake system will eventually absorb water.

The magic of diffusion allows moisture in the air to permeate microscopic pores in the rubber brake hoses, the nylon master cylinder reservoir, and the various rubber seals in the hydraulic system. Sadly, there is nothing we can do about it, and if left unchecked the water would sit in our brake system and rot it away from the inside out. If you never change your brake fluid, this is exactly what will happen.

Hence the need for brake fluid to absorb this unwanted house guest. Because brake fluid absorbs water into solution, the local concentration levels are typically low enough that corrosion is slowed dramatically. As an added benefit, when exposed to low temperatures the solution state prevents the water from pooling and freezing on its own. While water in brake fluid will certainly increase the solution viscosity at low temperatures, this is much more desirable than having little chunks of ice plugging up the system!

So, the next time you are bleeding your brakes to remove the water-contaminated fluid, don't curse at the automotive gods too cloudly. After all, the fluid was only doing its job.

### DOT Ratings

So, what exactly is the DOT rating telling us? More importantly, what is the DOT rating NOT telling us? A quick look at FMVSS116 (the US Government's regulation for brake fluids, comprised of no less than twenty-two pages of brake fluid minutiae) will tell us all we need to know.

### DOT 3 Fluid

DOT 3 fluids (such as shown in Figure 2) are usually glycol ether-based, but that is not because they are required to be. In fact, FMVSS116 makes no mention whatsoever about the chemical compounding of brake fluids—it simply dictates the fluid physical properties. However, the brake fluid industry has by consensus decreed that glycol ether fluids are the most economical way to meet the requirements, so there you are.

These glycol ether fluids are typically a by-product of the process used to make certain paints and varnishes. By definition, DOT 3 fluids must have a minimum dry boiling point (measured with 0% water by volume) of 401F and a minimum wet boiling point (measured with 3.7% water by volume) of 284F. That's really about all the specification says as far as the average consumer is concerned.

### DOT 4 Fluid

DOT 4 fluids are also glycol ether based, but have a measure of borate esters thrown in for increased immunity to water absorption. Because of this chemistry, the DOT 4 fluid will have a more stable boiling point during the early portion of its life, but ironically once the fluid does actually begin to absorb water, its boiling point will typically fall off more rapidly than a typical DOT 3. By FMVSS116 standards, DOT 4 fluids must have a minimum dry boiling point of 446F and a minimum wet boiling point of 311F.



Figure 2 – Typical garden-variety DOT 3/4 brake fluid.

### Is DOT 4 Better?

Does this make DOT 4 fluids better than DOT 3 fluids? Not always. Remember, the boiling points listed are minimums, and there are DOT 3 fluids out there with higher boiling points than some DOT 4 fluids. The real differentiating factor should be that if you run a DOT 4 fluid you really should change the fluid more often than if you use a DOT 3, if for no other reason than the rapid fall off in boiling point with time.

## DOT 5: A Different Animal

On their own, silicone-based DOT 5 fluids are entirely different animals than DOT 3 and 4 fluids. Their high boiling points—509F dry and 356F wet—make them appear at first glance like just the ticket for severe-duty applications. In addition, they also tend to have much, much lower viscosities, which improves cold weather performance dramatically.

Why not just pour it in and go? One side effect of this chemistry is that there is more “room” for air to fit in-between the individual molecules of brake fluid than in DOT 3 or 4 fluids. Note that we are not talking about big bubbles of air visible to the naked eye, but rather microscopic amounts of air which are finely dispersed (entrained) in the brake fluid matrix.

Now, all fluids have a certain amount of compressibility to start with, but adding even the smallest amount of air into the solution can dramatically increase the amount of elasticity in the system. In the case of silicone-based fluids, air is quite happy to take up residence between the brake fluid molecules, and, as a result, the fluid compressibility goes up. This is felt at your foot like stepping on a big spring. As you can imagine, more air = more spring. For this reason, silicone-based DOT 5 fluids are typically not favored in applications where high brake line pressures are present or when firm brake pedal feel is a critical design target.

Finally, because of the unique chemistry of the DOT 5 fluids, they cannot be mixed with DOT 3, 4, or 5.1 fluids. Think “oil and water.” Because it is relatively impossible to completely purge the system of old fluid when doing a fluid change, pockets of the silicone-based fluid will always remain isolated from the ether-based fluid. This can result in areas of localized water content, or areas of varying boiling points.

Because most modern vehicles come from the factory with DOT 3 or 4 fluids, it is a safe assumption that you should not even consider putting DOT 5 in your truck. In fact, the only production vehicles sold in the US that come from the factory today with DOT 5 fluids are Harley-Davidson motorcycles. Why? Because DOT 3, 4, and 5.1 fluids will mar the fancy paint on these machines if spilled, DOT 5 will not.

## DOT 5.1 Fluid

Historically, DOT 5-level performance (specifically boiling points and viscosity) could only be achieved with silicone-based fluids. However, modern compounding has created glycol ether-based fluids which now meet DOT 5 bogeys in these key areas. Consequently, the DOT 5.1 moniker was created to differentiate between these two very different chemistries, which both meet DOT 5 performance requirements.

In so many words, DOT 5.1 fluids (see Figure 3) are simply DOT 4-type fluids which meet DOT 5 performance requirements. Because of this, they typically can be mixed with DOT 3 or 4 fluids without concern. In some circles, they are even referred to as ‘DOT 4 Plus’ or ‘Super DOT 4’ fluids because they are more similar to a conventional DOT 4 fluid by chemistry than they are to a conventional DOT 5 fluid.



Figure 3 – Typical high-performance DOT 5.1 brake fluid.

While it may not be obvious, the big advantage of the DOT 5.1 fluids is that they contain all of the nifty water-absorbing characteristics of the DOT 3 and 4 fluids while simultaneously providing for very high boiling points and relatively stable viscosity over a wide range of temperatures. The best of all worlds, you could say.

So, what is the downside of the DOT 5.1 fluids? Like most things in life, the good stuff isn't cheap. DOT 5.1 fluids typically cost three to four times as much to manufacture as conventional DOT 4 fluid. There's always a catch, but you get what you pay for.

In summary, the chart in Figure 4 does a good job at comparing the four categories of brake fluid and their respective characteristics.

---

## Picking the Right Fluid

Ultimately, there is no magic here. However, be forewarned that if you are working your truck hard there are NO fluids which allow you to run indefinitely without periodic bleeding or replacement. The best that a fluid can do for you is provide stable, consistent performance during use; but because all fluids will absorb water over time, all fluids must be bled at some point. It's that simple.

As a rule, feel free to experiment with DOT 3, 4, and 5.1 fluids to find the right brand for your application, but steer clear of DOT 5. Remember, the DOT 5 silicone-based fluids are not miscible (a fancy way of saying compatible) with the ether-based fluids. Leave the DOT 5 stuff for the two-wheel crowd!

The chart in Figure 4 does a good job of comparing the four categories of brake fluid and their respective characteristics. Use it to find the best DOT 3, 4, or 5.1 fluid that fits your budget and is readily available to you. If your fluid never boils, you've arrived—there's your "right" fluid. However, if fluid fade persists, you may have to bite the bullet and pay up the ladder for the next best thing.

Property	DOT 3	DOT 4	DOT 5	DOT 5.1
Dry BP (F) @ 0.% H2O	401	446	509	509
Wet BP (F) @3.7% H2O	284	311	356	356
Chemical Composition	Glycol Ether Based	Glycol Ether/ Borate Ester	Silicone Based	Glycol Ether/ Borate Ester

Figure 4 – DOT requirement summary table.

James Walker, Jr.

TDR Writer

***Convinced that DOT 5.1 is the ticket for your next brake fluid maintenance? Check out the folks at EGR brakes as they are well known for their extreme-duty brake systems and fluids.***

---

## BRAKE BIAS

by James Walker

As you have probably noted in previous pages of the TDR, I regularly glean other automotive and technical periodicals in an on-going search for answers to questions from TDR readers about their trucks.

In one such search a couple of years ago in the pages of [Grassroots Motorsports](#) I found an article about brake systems by James Walker, which was so useful I decided on the spot that his presentation of information simply had to be made directly available to TDR readers.

The result was the series we commissioned Walker to write on the mysteries of braking systems appearing in the last four issues: the first to appear was "Brake systems in Plain English" in Issue 40, followed by "Brake Pad Selection" in Issue 41, "Twenty-one Brake Questions" in Issue 42, and "Brake Fluid Exposé" in Issue 43.

The past year has proved the merit of Walker's series on brake systems and demonstrated his ability to convey some highly technical information in very readable style and format.

James' facility in conveying this information is not surprising: he is eminently qualified to instruct us in these arcane matters. While he would not brag about his qualifications, I can boast a little about the extent of his background in brake systems.

His background includes employment at TRW (formerly Kelsey-Hayes), General Motors, Bosch, Ford Motor Company, and presently Delphi Corporation. When spare time allows, he serves as a consultant to StopTech, a high-performance brake systems company. James also participates in SCCA sports car club racing. In 2004 he will serve as an instructor at the Society of Automotive Engineers conferences. We should also watch for his articles on brake and suspension systems to appear in an upcoming special edition of [Car & Driver](#) magazine.

The four installments of James' series seemed so nearly exhaustive that at first I was at a loss for a topic he should address in this issue of the TDR. But my puzzlement was solved by the editors of [Grassroots Motorsports](#) who, apparently, were one jump ahead of me. In their January '04 magazine they had James write an article on front-to-rear brake bias and brake proportioning valves. *Voilà* (I said to myself in my best broken French), let's have James write two articles for the TDR covering brake balance (bias) and brake proportioning valves.

In suggesting to James a subject for his contribution to this issue of the TDR, I sent him a letter from a TDR member outlining the reader's experiences with a brake system.

That letter, suggestively titled "The problem with the front brakes may be the rear brakes," covered steps in adjusting the truck's height-sensing brake proportioning valve. Because the letterwriter was continuing in his experiment to improve feel in the brake system, I chose not to publish it until I had better understanding of hardware and dynamics. James' next two articles in this issue should provide us that understanding.

In this article covering front-to-rear brake bias, James will add a new wrinkle to the available traction equation-weight transfer. So James, the balance (pun intended) of the article is yours.

## WHY BALANCE (BIAS) MATTERS

Long, long ago in a magazine far, far away (actually, it was just a year ago in Issue 40, but who's counting?), a few renegade brake engineers rallied together to bring forward the following message:

*"You can take this one to the bank. Regardless of your huge rotor diameter, brake pedal ratio, magic brake pad material, or number of pistons in your calipers, your maximum deceleration is limited every time by the tire to road interface. That is the point of this whole article. Your brakes do not stop your truck. Your tires stop the truck. So while changes to different parts of the brake system may affect certain characteristics or traits of the system behavior, using stickier tires is ultimately the only sure-fire method of decreasing stopping distances."*

However, there's more to the story. Yes, the tires stop the truck, but improper front-to-rear bias (brake balance) can make a complete mess out of even the best components.

### THERE'S ALWAYS A "BUT", ISN'T THERE?

As braking force is continuously increased, one end of the truck will eventually break traction (skid). If the front wheels lock up and turn into little piles of molten rubber first, we say that the truck is "front biased," as the front tires are the limiting factor for deceleration. In the not-so-desirable situation where the rear tires are the first to lock, we say that the truck is "rear biased," but the driver would probably have a few more choice adjectives to add as the back of the truck tried to change places with the front end. However, in either case one end of the truck has given up before the other, thus limiting the ultimate deceleration capability of the truck.

In a racing scenario, the car with perfectly balanced brake bias will be the last one to hit the brakes going down the back straight prior to entering the next corner. By distributing the braking forces so that all four tires are simultaneously generating their maximum deceleration, stopping distance will be minimized and our brake system components will be operating at their maximum efficiency.

All that said, once the braking system has achieved its perfect balance, it is still up to the tires to generate the braking forces. It's still the tires that are stopping the truck. However, a poorly designed braking system can lengthen stopping distances significantly, expensive sticky tires or not.

### SO WHY IS BRAKE BIASING NECESSARY?

From Issue 40, "Brake Systems in Plain English," recall that the maximum braking force that a particular tire can generate is theoretically equal to the coefficient of friction of the tire-road interface multiplied by the amount of weight supported by that corner of the car or truck. For example, a tire supporting 500 pounds of vehicle weight with a peak tire-road coefficient of 0.8 (a typical street tire value) could generate, in theory, 400 pounds of braking force. Throw on a good race tire with a peak coefficient of 1.5, and the maximum rises to 750 pounds of braking force. More braking force means higher deceleration, so we again see the mathematical benefits of a sticky race tire.



On the other hand, if our race tire was now supporting only 300 pounds, the maximum force would drop from 750 pounds of braking force to 450 pounds of braking force—a reduction of 40%.

Since the amount of braking force generated by the tire is directionally proportional to the torque generated by the calipers, pads, and rotors, one could also say that reducing the weight on the tire reduces the maximum brake torque sustainable by that corner before lock-up occurs. In the example above, if an assumed 700 ft-lb. of brake torque is required to lock up a wheel supporting 500 pounds, then only 420 ft-lb. (a 40% reduction) would be required to lock up a wheel supporting 300 pounds of vehicle weight.

At first glance, one could surmise that in order to achieve perfect brake bias you could just:

1. Weigh the four corners of the truck
2. Design the front and rear brake components to deliver torque in the same ratio as the front-to-rear weight distribution
3. Be happy in your newfound brake utopia

In other words, for a rear-wheel-drive race car with 50/50 front/rear weight distribution it would appear that the front and rear brakes would need to generate the same amount of torque. At the same time, it would look like a production-based unloaded truck with a 60/40 front/rear weight distribution would need front brakes with 50% more output (torque capability) than the rears because of the extra weight being supported by the nose of the truck when unloaded.

Like most things in life, though, calculating brake bias is not as simple as it may appear at first glance. Designing a braking system to these static conditions would neglect the second most important factor in the brake bias equation – the effect of dynamic weight transfer during braking.

## THE EVER-PRESENT WEIGHT TRANSFER PHENOMENON

I'll apologize in advance to TDR readers who may expect that we would use a truck for this example. Unfortunately, this article was originally crafted for a slightly different audience, but rest assured that the same laws of physics and weight transfer apply equally to both race cars and diesel trucks.

That said, let's assume we have a 2500 pound car with a 50/50 static weight distribution. If we are concerned only with the vehicle at rest, it's easy to determine the weight on each wheel. We just need to find some scales and weigh it. The sum of the front corner weights is equal to the front axle weight (1250 pounds), and the sum of the rear corner weights is equal to the rear axle weight (also 1250 pounds). The weight of the vehicle is of course equal to the sum of the two axle weights (our original 2500 pounds), and this weight can be thought of as acting through the vehicle's center of gravity (CG). Figure 1 sums it up nicely.



Note that when at rest, there are no horizontal (left or right) forces acting on the vehicle. All of the forces are acting in a vertical (up and down) direction. But what happens to the vehicle when we start to apply forces at the tire contact patch to try to stop it? Let's find out.

During braking, weight is transferred from the rear axle to the front axle. As in cornering, where weight is transferred from the inside tires to the outside tires, we can experience this effect on our bodies as we are thrown against the seat belts. Consequently, we now need to add several more arrows to our illustration, but the most important factor is that our CG now has a deceleration force acting on it.

Because the deceleration force acts at the CG of the vehicle, and because the CG of the vehicle is located somewhere above the ground, weight will transfer from the rear axle to the front axle in direct proportion to the rate of deceleration. In so many words, this is the effect of weight transfer under braking.

This deceleration force is a function of a mechanical engineer's most revered equation,  $F=ma$ , where **F** represents the forces acting at the tire's contact patches, **m** represents the mass of the vehicle, and **a** represents the acceleration (or in our case, deceleration) of the vehicle. But enough of the engineering mumbo-jumbo, just have a look at these additional factors in Figure 2.

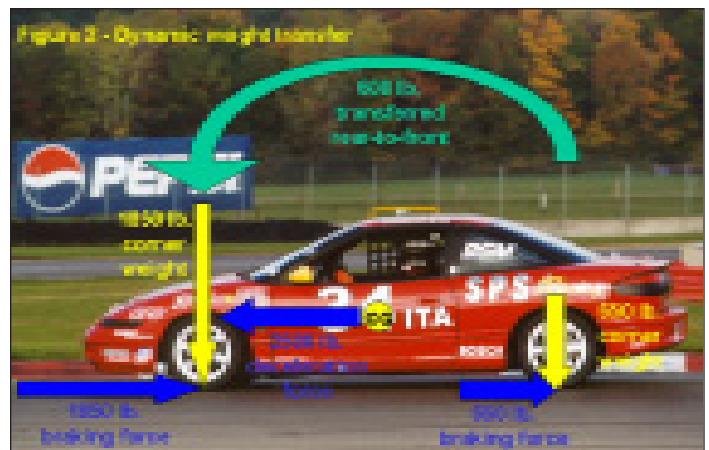

In Figure 3 (the beginning of what we call a “fishbone diagram”—more on this later), we see how our 2500 pound vehicle with 50/50 weight distribution at rest transfers weight based upon deceleration. Under 1.0g of deceleration (and using some typical values for our vehicle geometry) we have removed 600 pounds from the rear axle and added it to the front axle. That means we have transferred almost 50% of the vehicle’s initial rear axle weight to the front axle!

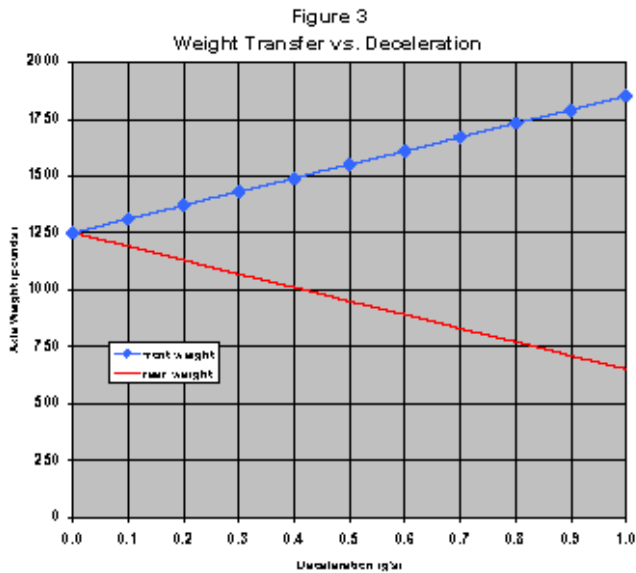

At this point, the brake system we so carefully designed to stop the vehicle with a 50/50 weight distribution is going to apply too much force to the rear brakes, causing them to lock long before we’re getting as much work as we could out of the front brakes. Consequently, the driver is going to get a white-knuckle ride because he creates more tire slip in the rear than the front, *and* it’s going to take longer for him to stop because the front tires are not applying as much force as they could be.

### SO WHAT INFLUENCES BRAKE BIAS?

If we look at the equations we have developed, we see that all of the following factors will affect the weight on an axle for any given moment in time:

- Weight distribution of the vehicle at rest
- CG height—the higher it is, the more weight gets transferred during a stop
- Wheelbase—the shorter it is, the more weight gets transferred during a stop

We also know from fundamental brake design that the following factors will affect how much brake torque is developed at each corner of the vehicle, and how much of that torque is transferred to the tire contact patch and reacted against the ground:

- Rotor effective diameter
- Caliper piston diameter
- Lining friction coefficients
- Tire traction coefficient properties

It is the combination of these two functions—braking force at the tire versus weight on that tire—that determine our braking bias. Changing the vehicle height, wheelbase, or deceleration level will dictate a different force distribution, or bias, requirement for our brake system. Conversely, changing the effectiveness of the front brake components without changing the rear brake effectiveness can also cause our brake bias to change. The following tables summarize how common modifications will swing front-to-rear bias all over the map.

#### Factors that will increase front bias

- Increased front rotor diameter
- Increased front brake pad coefficient of friction
- Increased front caliper piston diameter(s)
- Decreased rear rotor diameter
- Decreased rear brake pad coefficient of friction
- Decreased rear caliper piston diameter(s)
- Lower center of gravity (i.e. lowered truck)
- More weight on rear axle (i.e. loaded)
- Less weight on front axle
- Less sticky tires (lower deceleration limit)

#### Factors that will increase rear bias

- Increased rear rotor diameter
- Increased rear brake pad coefficient of friction
- Increased rear caliper piston diameter(s)
- Decreased front rotor diameter
- Decreased front brake pad coefficient of friction
- Decreased front caliper piston diameter(s)
- Higher center of gravity (i.e. lifted truck)
- Less weight on rear axle (i.e. unloaded)
- More weight on front axle
- More sticky tires (higher deceleration limit)

### PERFECTLY BALANCED, IN THEORY

Wow, look at all of the changes that an owner can effect and not even realize that he or she is tinkering with the vehicle’s front-to-rear brake bias! And, we didn’t even touch on other factors such as changes in the weather or road conditions (i.e., factors that can influence the total available tire traction).

While we can do calculations to determine what the optimum front-to-rear brake bias should be under all conditions, the difficult part is creating a brake system that can actually keep up with all of this.

A race car driver has it a little easier than those of us driving trucks in the real world. If he knows what his maximum deceleration capability is due to the tires he’s using, he can tune his brake system for that specific deceleration level. The good part is, if he tunes his vehicle for a 1.5g decel condition, because of the way weight transfer works, his car will be more front-biased in lower traction conditions, such as rain.

Back to the “fishbone diagram” mentioned earlier. Figure 3 shows front and rear axle weight versus deceleration of the vehicle. Now, let’s look at it as a percentage of the total vehicle weight. We can add on top of this chart the front-to-rear balance of the brake system. For example, if we use the exact same brake components at the front and rear axles of the car, they will each perform 50% of the braking, and the chart will look like Figure 4.

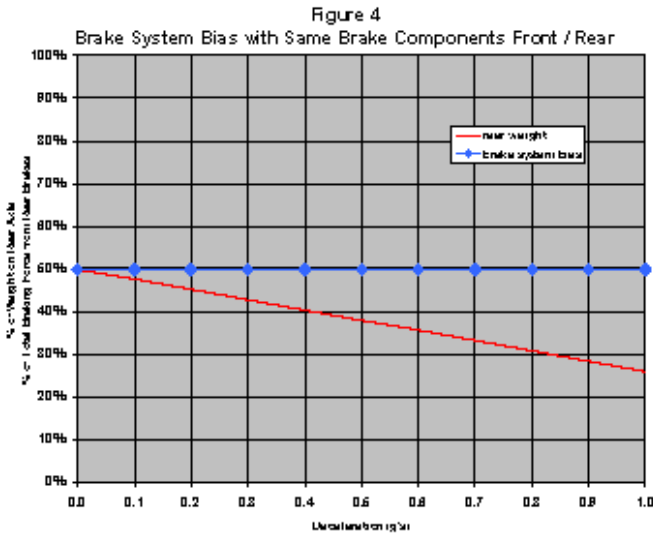

Evaluating this chart, we see that the vehicle will always be rear-biased. That is, the rear brakes will always be applying more force at the tire contact patch than the weight of the rear axle can sustain. This vehicle will always lock the rear brakes before the front. Not so good.

Most trucks, however, have brakes at the rear that are smaller than the front. There are a lot of reasons for doing this, and one of them is to help provide the correct brake bias. Also, most trucks have a proportioning valve which limits the amount of brake pressure seen at the rear brakes. If we look at the same chart with a more realistic braking system (one that takes into account these effects), it might look like the chart in Figure 5.

Perfect brake bias is obtained when the front-to-rear balance of the brake system exactly matches the front-to-rear weight balance of the vehicle. Looking at our typical brake system chart, we see how difficult this is to do. However, if we’re trying to optimize a brake system for a particular deceleration level, it becomes much easier. We can tune the system so that the two lines cross (or come close to it) at the deceleration level the vehicle will be operating at most often. This is easy for a racing vehicle which typically operates at one fixed deceleration level. But, for the rest of us, this is almost impossible to achieve, because a truck driven on the street doesn’t always operate at one deceleration level. (If yours does, you probably don’t get too many repeat passengers!) Compromises, compromises...

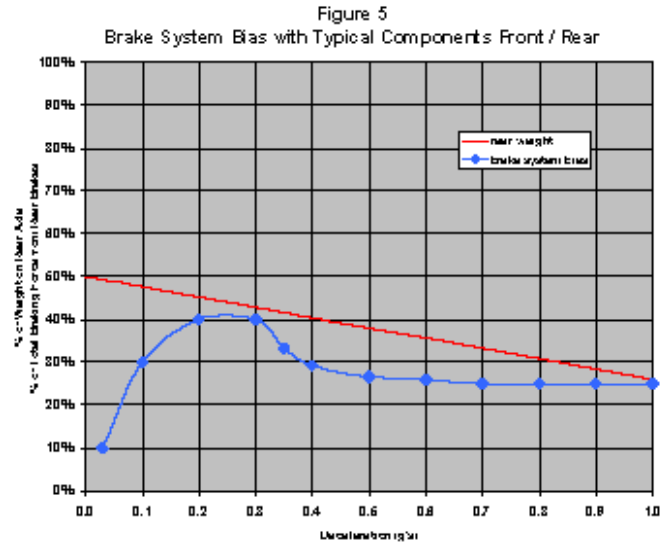

And here’s a free tip—effects of compromised brake bias on the street not only include sub-optimal stopping distances, but also include sub-optimal brake pad life. If a truck is too heavily front-biased in the deceleration range it typically operates in, it will wear front pads more quickly due to the fact that the rear brakes aren’t doing as much of the stopping work as they could be. However, the rear brake pads will probably last forever . . . sounds familiar, doesn’t it?

**PERFECTLY BALANCED, IN PRACTICE**

Brake bias can be measured in several ways. One method—the way the auto manufacturers do it—is to actually mount wheels on the vehicle that are equipped with strain gauges, so that the actual torque at each wheel can be measured throughout a stopping event. Analysis of the vehicle deceleration data combined with the measured torque values and knowledge of the vehicle parameters mentioned above (wheelbase, CG height, weight on each axle at rest) allow us to calculate brake bias for that particular event. This is the most precise method of measuring brake bias. However, there are simpler and cheaper methods that can be just as effective.

We know where most truck manufacturers tune brake bias—they like our trucks to be front-biased in all conditions achievable by the tires offered on the vehicle. This helps to ensure vehicle stability under braking by the mass public. If we measure stopping distance of the vehicle as delivered from the showroom floor, we have a good benchmark for a vehicle with a 5% to 10% front brake bias.

Now, if we make changes to the truck that can affect brake bias and re-measure stopping distance, we can tell immediately if we have taken a step in the wrong direction. For example, it is not uncommon to install more aggressive front brake pads (which will make the truck even more front biased) and see stopping distances go up 5% or more.

The most dramatic front-bias impacts are usually brought about by brake upgrades which are not properly matched to the intended vehicle. Any time that a bigger front rotor is installed, there is a simultaneous need to decrease the effective clamping force of the

caliper (installing smaller pistons is the easiest method) to offset the increased torque created by larger rotor effective radius. The objective is to maintain a constant amount of brake corner output (torque) for a given brake line pressure as Figure 6 illustrates.

**Figure 6**  
**Rotor Diameter vs. Piston Diameter For Equal Output**

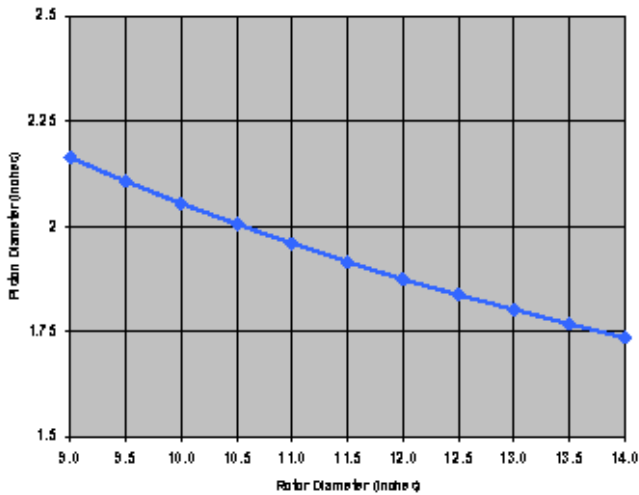

Unfortunately, too many junkyard swaps do not take this factor into account, and those poor trucks end up with both bigger rotors and larger pistons, which serve to drastically shift the bias even more forward. While rock-solid stable under braking, stopping distances will go *up* dramatically.

As Figure 7 illustrates (again, sorry for the non-truck data), every vehicle has a “sweet spot” for brake bias which will generate the shortest stopping distances possible. Typically, the auto manufacturers design their trucks to be 5% to 10% more front-biased than optimum for maximum deceleration, but they provide enhanced brake stability in return, and that’s not a bad trade-off for the public at large.

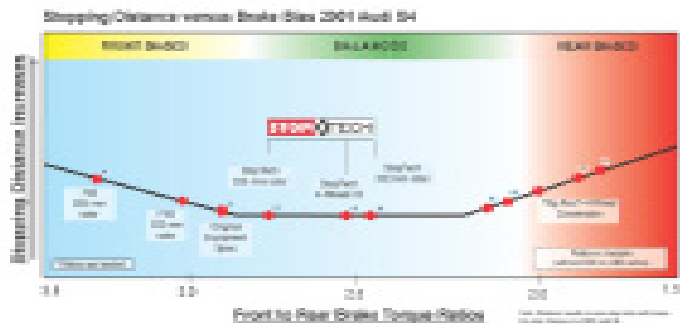

The flip side can be seen by making changes to increase the amount of rear bias. Because the truck manufacturers leave a tiny (and we mean tiny) bit of wiggle room in their designs, it is usually possible to make small changes to increase rear bias and end up with shorter stopping distances than stock. Keep in mind, however, that there is only so much of this wiggle room to play with. After a point, increased rear bias will make the truck unstable under hard braking and will consequently drive the stopping distances through the roof.

## WHAT ABOUT TRUCKS EQUIPPED WITH ABS?

Anti-lock braking systems can throw yet another factor into the bias equation. While on the surface it may look like ABS would mask some of the effects of compromised brake bias, it is certainly not a cure-all for bias gone bad.

Under full-tilt, stop-the-truck-right-now braking, ABS attempts to cycle all four wheels at their peak traction levels, regardless of the mechanical bias relationship in the braking system. Because ABS will not allow any of the wheels on the truck to lock, balance is naturally maintained and stability is ensured for the braking event.

However, bias can still rear its ugly head on trucks equipped with ABS. Specifically, your truck as delivered by the factory is calibrated to enter ABS under a certain set of dynamic conditions, some of which can be influenced by brake bias. While ultimate stability is not at stake, compromised bias can trigger ABS entry conditions more frequently, as the ultimate deceleration threshold just before ABS control is now lower.

What this means to the driver is that ABS could be more susceptible to false activations or nuisance cycling. This is more of an annoyance than a safety concern under most scenarios, but does anyone really want his truck to be cycling the ABS every time they hit the brake pedal? Didn't think so.

And while we are at it, we should also not forget the impact to brake pad life which comes with compromised bias, ABS equipped or not.

So, while ABS may be able to mask some level of instability under maximum ABS braking, it certainly is not a silver bullet for compromised bias. Even ABS-equipped trucks need to be designed with proper brake bias.

## THE MORAL OF THE STORY

As you go about modifying your truck, be aware that changes in the braking system as well as changes in the truck's ride height, weight distribution, or physical dimensions can swing brake bias all over the place. The only sure-fire way of knowing if your final bias has been optimized is to measure stopping distance both before and after your modification(s).

In summary, your tires certainly still stop the truck, but if your bias is out in left field, you might not be able to use everything they have to offer. Your braking system is just that—a system—and keeping an eye on brake bias effects during modification will go a long, long way toward efficient brake system operation.

In the next issue of the TDR we will delve into what is probably the most misunderstood and misused component of the braking system—the proportioning valve. While some may view this device as another bias cure-all, there is more to the story that needs to be shared before one goes fiddling around under the truck. Stay tuned!

**James Walker, Jr.**  
**TDR Writer**



## THE MYSTERIOUS PROPORTIONING VALVE

by James Walker

### A horribly misunderstood, misused, and misnamed brake system component

In Issue 44 we discussed the glory of front-to-rear bias, or brake balance, and how its optimization could lead to better braking performance. However, one critical factor in establishing bias—the proportioning valve—was left out of the discussion. After all, one can only take so much of this brake talk in one sitting.

That said, we are back to fill you in on the intricacies of just how brake torque is proportioned to the front and rear of the vehicle. More importantly, we hope that you take away the understanding that adjustment of the typical pickup truck height-sensing proportioning valve can do more harm than good. Because such an adjustment is not magic, there are plenty of opportunities to throw the system into disarray without even knowing it.

#### Proportioning valve basics

Let's get this out of the way right now—when it comes to boring truck parts, the proportioning valve must be sitting towards the top of every enthusiast's list.

<Pause>

Okay, that's better. Now before everyone throws brake design to the wind in the hopes of fixing everything with the magic proportioning valve, let's take a quick look into these devices and their related mechanical siblings. While a properly designed and used proportioning valve can put the finishing touches on a properly designed and installed brake system, they should not be thought of as a one-stop, fix-o-matic for brake balance disasters.

In general, there are three ways to deal with rear brake pressure—leave it alone, make it proportional to the front brake pressure, or control it in such a way that these two concepts are combined.

#### Concept 1: Leave it alone

If no device at all were used to modify the rear brake pressure, the front brake pressure and rear brake pressure would always be equal. This relationship can be seen in Figure A. Theoretically this equation would be the easiest way to deal with the pressure, but in order to prevent rear bias under all conditions the rear brake itself would need to be absolutely tiny. As you can imagine, this is not a realistic solution, but we have included it for sake of comprehensiveness.

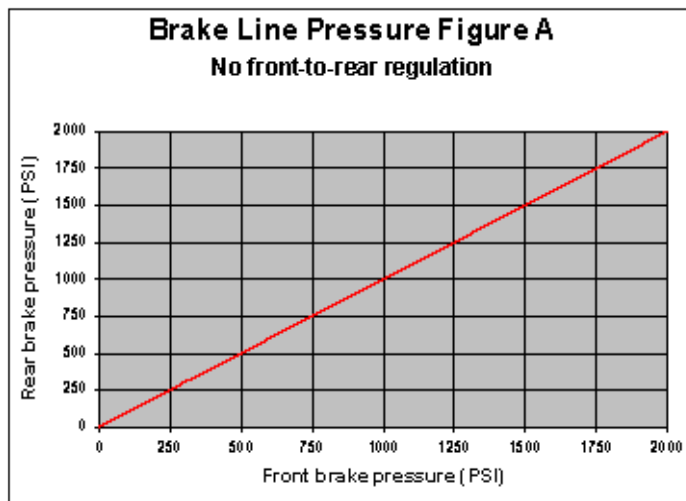

#### Concept 2: Rear pressure proportioning

True proportioning would result in rear brake pressures being linearly proportional to front brake pressures under all conditions. This type of pressure regulation is certainly possible to achieve, but normally it requires tandem master cylinders and an adjustable balance (or bias) bar—the same setup found on nearly every purpose-built racing car today. This relationship can be seen in Figure B. The proportioning ratio can be achieved through either master cylinder piston diameter selection or through the adjustment of a mechanical reaction linkage which connects the two master cylinders (the bias bar). Ironic as it may seem, proportioning valves cannot provide this kind of control, for they are not purely proportional devices as their name would imply.

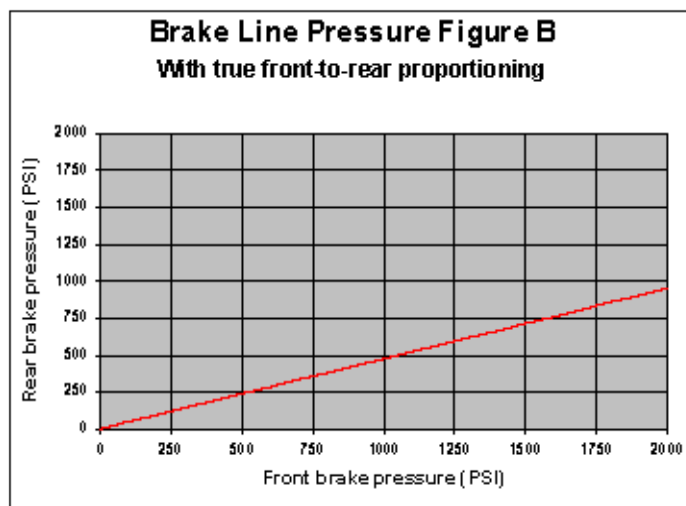

Because of the complexity involved with a dual-master cylinder set-up, this type of proportioning is rarely—if ever—found on passenger cars, and certainly not on modern trucks.

## Combining concepts: The brake system proportioning valve

Proportioning valves (perhaps more accurately referred to as “braking force regulators” or “brake pressure regulating valves”) provide a combination of the control found in Figures A and B. Up to certain pressures, these valves allow equal pressure to both the front and rear brakes (see Figure A). However, once a preset pressure point is reached (600psi in the example) the rear brake pressure continues to build, but at a slower rate (or slope) than the front brake pressure. Figure C displays this quite clearly.

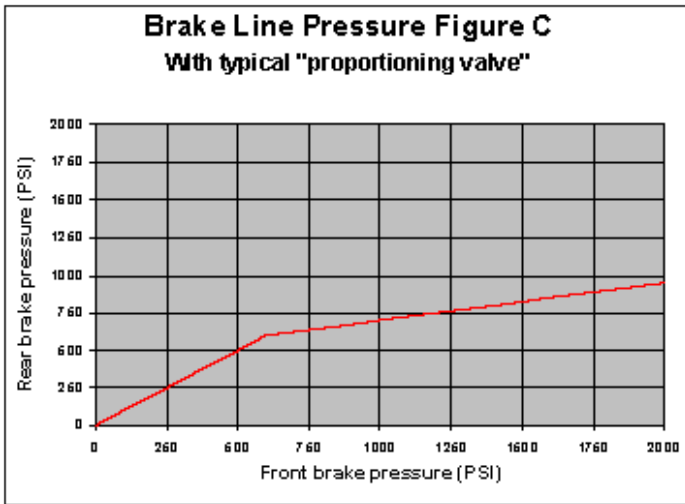

Because of their compact size and relatively low cost, these devices can be found on nearly every vehicle requiring rear brake pressure reduction to achieve optimum brake bias. Pickup trucks fall neatly into this category.

The Dodge Ram truck's proportioning valve goes one step farther, however, as the kneepoint on the graph above varies with the amount of weight in the bed. In effect as the weight in the bed increases, a linkage between the axle and the frame is compressed. This linkage acts on a cam inside the proportioning valve to increase the preload on the proportioning valve spring. The end result is that more rear braking (bias) is allowed as weight is added to the bed, helping to take advantage of the increased traction now available at the rear tires. Figure D illustrates this relationship quite clearly.

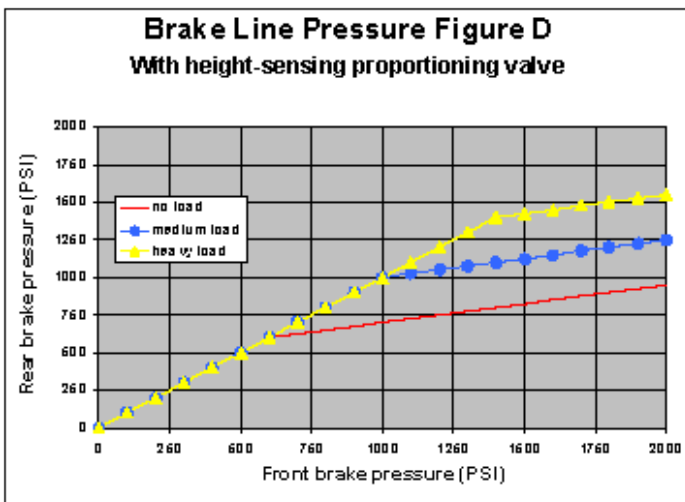

## So, how can one adjust the proportioning valve?

Believe it or not, in nearly all cases the OEM valves are well matched to the original brake system and should not be tampered with, as there are no parts inside that are able to be modified by ambitious owners. Unfortunately, they are externally adjustable, so the temptation to tinker is right there in front of us!

One point to ponder is that because they are a mechanical device, proportioning valves must be designed as a best compromise for use under all conditions. High speed, low speed, fully loaded, and empty-bed scenarios must all be evaluated and figured into the proportioning valve design.

Of course if you have modified your truck in a way that impacts front-to-rear bias you might be standing out in left field! From our bias article in Issue 44, we will bring forward again the lists of modifications which can influence front-to-rear bias.

### Factors that will increase front bias

- Increased front rotor diameter
- Increased front brake pad coefficient of friction
- Increased front caliper piston diameter(s)
- Decreased rear rotor diameter
- Decreased rear brake pad coefficient of friction
- Decreased rear caliper piston diameter(s)
- Lower center of gravity (i.e. lowered truck)
- More weight on rear axle (i.e. loaded)
- Less weight on front axle
- Less sticky tires (lower deceleration limit)

### Factors that will increase rear bias

- Increased rear rotor diameter
- Increased rear brake pad coefficient of friction
- Increased rear caliper piston diameter(s)
- Decreased front rotor diameter
- Decreased front brake pad coefficient of friction
- Decreased front caliper piston diameter(s)
- Higher center of gravity (i.e. lifted truck)
- Less weight on rear axle (i.e. unloaded)
- More weight on front axle
- More sticky tires (higher deceleration limit)

## Proportioning modifications

We could start this section by clearly stating that you should not modify your proportioning valve. But, what fun would that be? In all seriousness, making changes to the proportioning valve to affect brake bias should be left to those with the proper tools and measurement devices, but if you have tweaked your truck beyond recognition, this may be your only solution to restore a sense of proper bias to your braking system.

We'll start here with three of the most basic rules regarding proportioning valve installation and selection:

1. If you have the deeply-rooted need to install your own adjustable proportioning valve, be advised that they should NEVER be installed if the factory unit is still in place. Proportioning valves in series with one another can do nasty, unpredictable things!
2. If you have the deeply-rooted need to install your own adjustable proportioning valve, be advised that they should NEVER be installed in-line to the front brakes. The effect would be to make your truck rear-biased before you could say "rear skid, out-of-control." Front brake line pressure should always be left alone—only the rear pressures should be considered for proportioning.
3. In all cases, the basic brake system balance needs to be close to optimum to start with. This is the only way that a proportioning valve can be effectively utilized.

## Proportioning valve selection

If we have not scared you off to this point, maybe this will. Selecting the correct adjustable proportioning valve for your truck entails not only selecting the proper point at which slope limiting begins (the kneepoint), but also selecting the proper rate at which rear brake line pressure builds after that point. Nearly every adjustable proportioning valve on the market today has an adjustable knee point (the point at which the rear brake line pressure begins to be controlled), but a fixed slope (the rate at which it builds beyond the knee point). One parameter is adjustable, but both are critical to system performance. Note that in Figure E the two curves have the same knee point, but the slopes vary greatly.

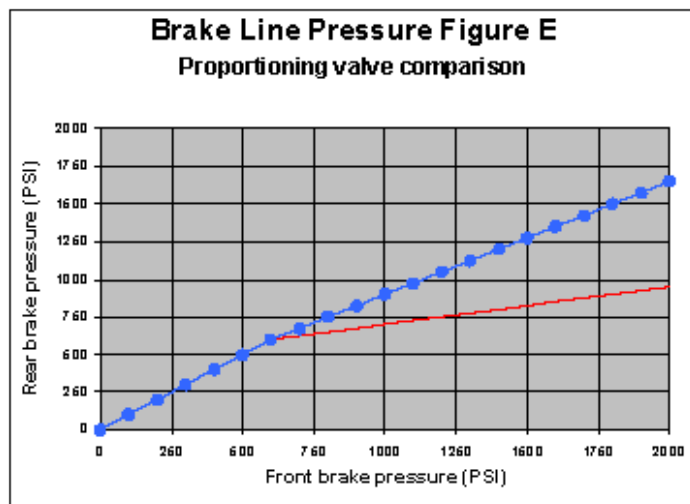

So how does one select the right kneepoint and slope? Without the test and measurement resources of a major automotive manufacturer, it's next to impossible to say. Of course, you could trial-and-error your way into a situation that you believe to be appropriate, but without testing under all conditions of loading, speed, and road conditions there might be one rear-biased operating condition just waiting to bite you.

## Electronic proportioning: No tampering allowed

As a small sidebar to this discussion of the mechanical proportioning valve, there is a movement afoot to replace the proportioning valve function with the hardware performing the ABS function. While this is not yet the norm, one can predict with reasonable certainty that the trend will continue.

Based on information gathered from the four ABS wheel speed sensors, the Dynamic Rear Proportioning (DRP) algorithm calculates the front-to-rear slip ratio of the four tires. Then, given preset thresholds and parameters, the ABS hardware can intervene and modify the brake pressure going to the rear wheels automatically.

Because DRP is based on actual wheel slip and not on brake line pressure, this type of rear proportioning is more flexible and adaptable to modifications one might make to their truck. It is also less expensive, as the OEM can now remove the mechanical proportioning valve from the truck and replace its function with other hardware already on board.

Naturally, the OEM does not want owners fiddling with their front-to-rear proportioning, and as a result there is no way for the enthusiasts to reprogram DRP to suit their desires. Of course, if the truck's original front-to-rear bias is intact in the first place, there is no need to reprogram anyway.

## So what's the final answer?

In summary, there is more to the proportioning valve than meets the eye. You should make every attempt to plan and select any brake modification carefully so that you are able to retain and reap the benefits of the stock proportioning valve. In other words, pay attention to (and don't stray too far from) the factory bias in the first place and you will be ahead of the game.

If for other reasons you are forced to scrap the stock unit and replace it with an aftermarket unit, be advised that selection and adjustment are not for the uninitiated. While there is more than one way to achieve optimum balance at the point of maximum deceleration, without the right amount of know-how you might be making compromises under partial braking conditions that were not present with the factory hardware.

**James Walker, Jr.**  
TDR Writer

---

## BRAKE UTOPIA

by James Walker

Quite simply brake vibrations are never a good thing. In fact, a common saying in the brake industry is, "The best brake system is an invisible brake system." Let's try to understand why this can sometimes be difficult to achieve.

You press the brake pedal and your truck slows down. There's no squealing, no shaking, and no vibration. You have arrived at brake utopia.

Unfortunately, brake utopia can sometimes be in another area code.

Pick your favorite brake system malady: brake roughness, pulsation, shudder, hot judder, shake, vibration, or the all-time favorite, rotor warping. To the brake engineer these all have slightly different meanings, but to the average consumer they are all simply a problem that has to be addressed.

Few vehicle problems are as annoying as a problematic brake system. While usually not a detriment to brake system effectiveness at first, none of these conditions can be considered desirable; and, if ignored long enough they can have legitimate performance impacts.

So what causes these conditions, and what can be done to prevent them in the first place? We'll get there, but first we should briefly review what we learned about brakes back in Issue 40.

### The Brakes Don't Stop the Truck!

What does the brake system do? The brake system's primary responsibility is to convert the kinetic energy of the truck in motion into thermal energy, or heat. If there is available tire traction (tire-to-road friction) the truck certainly may decelerate, but the brakes do not stop the truck. That's the job of your tires.

No tire traction, no tire force, no deceleration. Hello, tree. Thud!



**Regardless of how large, colorful, or sexy your braking system components, it's still the tires that stop the truck!**

If we look in more detail at the brake pad and rotor interface, we discover that this is where most of the energy conversion takes place. It is the friction between the brake pad and the spinning rotor that creates heat while simultaneously building torque in the rotating brake parts. Over the next few paragraphs we will be dissecting this dynamic interface.

As the saying goes, you paid for the whole seat, but you'll only need the edge!

### The Two Types of Friction

Who takes the time to worry about how the stationary brake pad and the spinning rotor generate friction? Odds are this question has never passed through your mind, but it is paramount to understanding brake vibrations.

Brake pads engage in two distinctly different types of dynamic friction: abrasive friction and adherent friction. The details should be left to the PhD community, but in general the two modes operate as follows:

In the abrasive mode, friction is generated as a result of interference between the microscopic high and low spots on the brake pad face and the spinning rotor. In very simple terms, this is similar to holding a block of wood on a belt sander. As the high and low spots are slowly machined away (much slower than the wood on the belt sander, of course), this breaking of molecular bonds creates a force which resists the rotation of the rotor. It also heats up the materials involved. Breaking molecular bonds has a tendency to do that.

Presto! We have converted kinetic energy into thermal energy by breaking a bunch of molecular bonds. Not too surprisingly, this is the mode that most people naturally envision when asked to explain how brake pad friction operates.

Adherent friction is quite different in nature. In the adherent mode, pressure and temperature collaborate to deposit a thin layer of brake pad material, or a transfer layer, on the rotor face. Subsequently, as the caliper squeezes the brake pads against the rotor, the pads contact the transfer layer, not the rotor itself.

As the pressure increases, molecular bonds are then very quickly formed between the similar materials of the brake pad and the transfer layer. Just as quickly, however, those very same bonds are broken as the rotor continues to move relative to the brake pad. As a result, heat is generated and the brake pad material wears away.

In summary, abrasive friction can be found between the brake pad and the rotor itself, slowly wearing away both materials, breaking bonds, and generating heat and torque in the process. With adherent friction, however, the rotor never actually wears. Because all of the bonding-breaking action is occurring between molecules of the brake pad material, only the pad itself wears away over time.